

Installation Manual



4K4LT Low Voltage Module



IMPORTANT ANNOUNCEMENT

The 4KLT battery is a different model from the previous 4K4, 4K4 PRO series.

4K4LT has different technical characteristics from the 4K4PRO; therefore, the connection with previous models must be evaluated and understood before being implemented by the installer.

Compatibility, although guaranteed at FW level, may require specific evaluations and preparations on the 4K4 models of the previous series to which the new 4K4 LT could be connected.



IMPORTANT ATTENTION

The 4K4 LT firmware has a different nomenclature starting with 16.xx, this firmware is developed specifically for the LT series BMS and cannot be used on 4K4/4K4 R and 4K4 PRO batteries.

Do not attempt to install firmware from other batteries, otherwise, the BMS may freeze permanently.

Before connecting a 4K4 LT battery with previous series batteries in parallel, send an email with the serial of the batteries you intend to connect in parallel with the new 4K4 LT and you will be provided with a dedicated guide and specific firmware updates for both battery models.

FOREWORD

The evaluation of the product is an important and necessary phase and must precede the purchase, it is recommended to evaluate the latest datasheets made available at www.wecobatteries.com site or request a copy directly from weco@wecobatteries.com.

Our products and manuals are mainly intended for installers and technical experts with specific qualifications for electrical installations.

The manual, the system certification and the test certificate "first ignition" of the entire system, must be delivered to the end user after adequate training on the use and maintenance of the battery and the system in general.

These batteries are intended to be marketed to be integrated into more complex systems installed only by professional operators.

After reading the manual in full, we hope that you will be able to buy our products.

Before buying, please carefully evaluate the technical characteristics with the data provided on our website, which are the only updated and official data concerning our products.

The pre-purchase evaluation is an important phase and for this reason it must be conducted carefully and perhaps with the help of qualified and experienced technicians, if your knowledge on the subject is not sufficient.

WeCo batteries are developed for domestic and industrial applications and can only be installed and maintained by experienced and qualified personnel, they are not produced for direct sale to private individuals.

This manual provides detailed information on the operation, maintenance and troubleshooting of the product, as well as health and safety advice; the information in this manual may not be sufficient to cover specific applications, so if your specific case is not mentioned, please do not purchase our batteries until every technical and safety aspect of your specific application has been clarified. You can request technical support at service@wecobatteries.com.

SPECIAL ANNOUNCEMENT:

The manufacturer reserves the right of final explanation of any content of this manual.

The warranty conditions and technical data are on our website and may vary according to product updates.

On the site you will find the most up-to-date versions of the manual and datasheets, always check before buying.

Before buying you can ask for support by sending an email to weco@wecobatteries.com.

SYSTEM DESIGN BY EXPERT TECHNICIANS

Systems Design is the process of defining the architecture, components, modules, interfaces, and load data for a system to meet specified requirements.

For a solar system these components are the photovoltaic modules, the inverter / charge controller and the batteries as well as the different interfaces of these components.

These systems must be integrated with each other in accordance with their respective technical rules and must be compatible.

BATTERY OPERATION

There are several factors that affect the operation of the battery regarding its ability to provide capacity and life expectancy.

STORAGE

Battery Module shall be stored in original packaging, in a clean, level, dry, cool location indoors.

Recommended storage temperature is 77°F / 25°C, but different storage range are acceptable:

range of 14°F to +32°F / -10°C to +0°C: inspection* and recharge** every three months required.

range of 32°F to +86°F / +0°C to +30°C: inspection* and recharge** every six months required.

range of 86°F to +113°F / +30°C to +45°C: inspection* and recharge** every three months required.

(NOTE: max charging current is 0.1C at a temperature not lower than 15°C).

Max SoC for sea shipping is now 30% as per the recent changes of the UN 38.3 regulation.

*Inspection parameters – identify the State of Charge (SOC), look for alarms and address them accordingly, look for physical damage to the Battery Module.

**Charge at 0.1C up to 50% SOC and then discharge to the limit of SOC allowed by the local regulations. Suggested SOC 30%~50% when stored on land.

If shipped by sea, you must refer to the UN38.3 standard; if by road, refer to the local codes.

Temperature of Use and threshold

Many chemical reactions are affected by temperature and this is also true for the reaction that occurs in a storage battery.

The chemical reaction of a lithium ion is slowed down by lowering the temperature of the electrolyte, which results in a lower capacity.

A new battery providing 100% of the nominal capacity at 25°C will provide only about 75% of the nominal capacity at 10°C.

At temperatures below -7°C the BMS will only allow 0.05C of charge current; at temperatures below -10°C charging is prohibited. These thresholds do not mean that the battery performance warranty also applies under such conditions.

The warranty conditions are well described in the document "Limited Warranty" and must be read before purchasing the product.

As part of the performance guarantee, charging and discharging must be carried out according to the performance warranty conditions; Any use outside this range is not covered by the performance warranty.

Depth of discharge (DoD %)

The depth of discharge is a function that is implemented through the setting of the hybrid inverter, compatible with WeCo.

The deeper the discharge, (e.g., DoD 100% means a completely discharged battery), the shorter the battery life in its estimated lifetime.

A cycle is complete when all the nominal energy is discharged and is subsequently recharged, regardless of the depth of discharge.

The number of cycles and the specific DoD will affect the expected life in years that the battery/battery system will provide before replacement.

To maximize the remaining capacity in the period of the useful life of the battery, it is recommended to set the DoD of the inverter to the value of 20%, this will keep the status of health (SoH) for longer.

Charge

Most capacity/battery life issues can be traced back to improper charging. Improper charging settings can lead to an overload or over-discharge condition. The temperature heavily affects the performance of the battery but also has direct effect on the safety of the cell due to mechanical modification that might occurs during the charging process at low temperatures. A lithium battery's charging process shall always be performed above zero Celsius and in the range of +15 +30 to ensure safety and performance reliability.

WeCo guarantees only batteries connected via BMS CAN line to the compatible inverter (see compatibility list on the www.wecobatteries.com website) and used according to the warranty requirements published on the site.

Modern inverters / charge controllers are equipped with CAN / BMS interface and no battery settings are required to charge and discharge the battery, except for the charging / discharging power setting and DoD % (if the customer wants to comply with the STC requirements he must read and comply with the warranty conditions defined STC).

The maintenance at optimal temperature instead must be guaranteed by the technical room and air conditioning equipment installed in it.

Guarantee

Although battery BMS allows a wide range of use in terms of both temperature and charging currents, this should not be interpreted as an implicit authorization to use the battery at these levels.

For the purposes of the performance guarantee, it is mandatory that the battery is used within the temperature range and charge/discharge current and depth of discharge indicated in the performance guarantee.

Any other use, even if permitted by the BMS ranges, is not covered by a performance guarantee and is not recommended.

Firmware Updates

In case of updates to the 4K4LT product or for other reasons, this manual and warranties may be updated accordingly. Verified critical firmware release notes on the www.wecobatteries.com site. Critical release firmware must be installed as per warranty requirements: To obtain support or if your system is not equipped with a WiFi module contact service@wecobatteries.com.

Imprint

Unless otherwise agreed, this document is intended to be used only as a guide to installation, maintenance and management of the product, all statements, information and advice contained in the documentation do not constitute any explicit action or implied statement in contradiction with local regulations or standards.

For more information, please contact us.

Official information and the latest datasheet are available on www.wecobatteries.com; Hyperlinks, third-party links, datasheets published on social media web or printed may not be updated to the current version. Before purchasing the product, check the technical data and warranties updated to the current date on the site.

It is essential that the battery unit is equipped with the latest firmware version available on the www.wecobatteries.com website.

From time to time, WeCo will release a new firmware to improve the functionality and capabilities of the battery, if your battery will be equipped with WiFi (optional item) and you will be registered on our APP, the new firmware will be visible and updatable from the APP.

The latest firmware version is always available for free; the battery firmware can be updated by the local installer (reserved for technical installers) or via APP for batteries equipped with WiFi dongles.

You can also write an email to service@wecobatteries.com to understand the upgrade process.



ATTENTION

The 4K4 LT battery module is designed to be used indoors in temperature-controlled environments.

The STANDARD IP20 degree of protection does not allow installation in outdoor environments even if protected from the weather.

The definition INDOOR means the indoor environment, the room must be closed to unauthorized persons, ventilated and dry.

Use in an external environment or not compliant with the IP grade is prohibited and potentially dangerous for the health of people and / or things.

SAFETY CONCERNS AND PRECAUTIONS



WARNING: The battery may explode and/or suffer serious damage if it falls or is crushed.



WARNING: The battery may explode when exposed to open flames or other extreme heat sources.



CAUTION: The battery terminals must be disconnected before starting any work on the battery.



WARNING: This battery can accumulate eddy current. Do not touch terminals B+ and B-. Always check terminals B+ and B- with a

voltmeter.



ATTENTION: Always check for ZERO volts on the terminals before performing any operation on the battery.



WARNING: Always wear personal protective equipment, use insulated tools and follow the safety plan of this manual.



ATTENTION: it is necessary to use appropriate mechanical lifting equipment as the battery module weighs 47 kg.

DISPOSAL INFORMATION



At the end of their life, these batteries must be properly disposed of by a certified professional company in accordance with applicable laws.

SUMMARY

PREFACE

INFORMATION IN THIS MANUAL

- 2.1 About this manual
- 2.2 Usage range
- 2.3 Additional information
- 2.4 Symbols used.

SAFETY

- 3.1 Warnings and notifications
- 3.2 Safety Guidelines

PRODUCT OVERVIEW

- 4.1 Product Introduction
- 4.2 Identification of product components
- 4.3 Definitions of the LED bar

SYSTEM INSTALLATION

- 5.1 Installation Notice
- 5.2 Packaging information and parts list
 - 5.3.1 Installation procedure (wall mounting)
 - 5.3.2 Installation procedure (stacked mounting)
- 5.4 Communication and control panel
- 5.5 DIP switch settings
- 5.6 Parallel battery ablation convention

BATTERY ACTIVATION AND SHUTDOWN

- 6.1 Panel button and LED explanation
- 6.2 Stand-alone battery front panel control
 - 6.2.1 Switching on the fuel.
 - 6.2.2 Switching off the battery.
 - 6.2.3 Low battery force charge function
- 6.3 Parallel battery configuration
 - 6.3.1 Switching off parallel batteries.
- 6.4 Forced Charge

CAN HUB FOR MULTI CLUSTER

UTILIZE DONGLE WIFI – BLUETOOTH

DRY CONTACTS SETTINGS

TROUBLESHOOTING

1 PREFACE

WeCo strives to provide the best technical solutions in the industry and your every advice for product improvement is taken seriously.

To prevent damage and injury to both personnel and the product, please read this manual carefully.

This manual provides detailed information on product operation, maintenance and troubleshooting, as well as health and safety advice.

For warranty, technical data and guaranteed performance, reference should be made to the latest official limited warranty document.

STORAGE AND PRE-OPERATIONAL PROCEDURES

1.1 Storage - Transport - Removal / Transfer of batteries

- ✓ This battery is considered DANGEROUS GOOD by the United Nations and must be treated accordingly.
- ✓ Each box comes from the factory with the labels below:



- ✓ This battery can only be transported and stored with the original cardboard box approved and certified according to UN CLASS 9 Y80.
- ✓ This battery should be stored in its original cardboard box in a dry and cool place, the WeCo cardboard box is marked as below:



- ✓ The SoC during transport and storage must not exceed the legal limits ADR / IMDG and Local Laws.
- ✓ The storage period without refill is 3 months, after which a recharge of up to 50% DoD is required and discharge to the SoC required by law for storage conditions.
- ✓ Charging current shall not exceed $e 0.5 C$ at $25^{\circ} C$.
- ✓ To preserve the performance and durability of this battery, store it at $25^{\circ} C$ and 70% humidity.
- ✓ The optimal battery storage temperature is between $15^{\circ} C$ and $35^{\circ} C$.
- ✓ The car discharges in the range $15-35^{\circ} C$ is about 1% per month, outside this range it may exceed 10% per month.
- ✓ Do not store batteries near sources of heat, steam, gas, fuel, sparks or anything that could generate fire or explosion.
- ✓ Store inside and protect from water and moisture.
- ✓ The transport of new and used or damaged modules must comply with the UN ref. Section DG9 38.3 and local standards.
- ✓ If one or more work unit's dev and be removed and or repositioned and, each dev and be individually marked as **USED BATTERY** (follow local rules).
- ✓ If one or more modules need to be replaced due to damage, each must be individually marked as **USED BATTERY DAMAGED**. Follow all applicable procedures for the country and local regulations.

2 INFORMATION IN THIS MANUAL

2.1 About this manual

This manual refers only to the universal low-voltage stackable model 4K4LT. This manual is intended to be used only by qualified installers for the evaluation and installation of the product who must carefully read and always refer to the manual to ensure maximum safety and correct product operation.

The installer must inform the end customer, user, of the need to conduct scheduled maintenance to the product and possibly propose a maintenance and after-sales control service, privately agreed between the parties.

2.2 Usage range

This installation guide applies only to the 4K4 LT.

2.3 Additional information

Product specifications may be changed without prior notice to customers, so the customer or technician should check before purchasing and/or installing the product.

2.4 Symbols used.

Meaning of symbols:



Caution:

CAUTION represents dangerous situations that can cause light injuries if not avoided.



Notice:

NOTICE represents situations that can cause damage to property if not avoided.



Information:

INFORMATION provides valuable tips for optimal installation and operation of the product.

3 SECURITY

3.1 Warnings and notifications

Installation Environment Requirements: 4K4LT is designed for indoor and domestic applications (IP 20) and therefore must be installed in an IP20-compliant location. Installations in places that do not comply with the IP20 degree of protection may cause failure and / or damage to the product and subsequently the product warranty will be considered void.

3.2 Safety Guidelines

⚠ Caution:

Always make sure to avoid a short circuit between the positive terminal and a negative battery terminal.

All electrical connections of the 4K4LT must be made only by qualified professional personnel.

When installed and used in accordance with this manual, the 4K4LT series battery will operate safely and reliably in accordance with the battery operation specifications.

Subjecting the battery to an unsuitable operating environment, operating it as a result of failure, damage, abnormality, misuse or abuse may result in health and safety risks, such as overheating or potential electrolyte smoke caused by use out of operating range permitted by WeCo. All personnel and /or users must observe safety precautions and observe all warnings as detailed in this document. If any of the safety precautions or procedures described in this manual are not fully understood by the reader, the reader, if it is not a qualified installer, should not perform any operation on the battery until the problem is identified. The correct operation in case of anomaly is always the shutdown and isolation of the battery of the rest of the system. To clarify and confirm your understanding of the correct procedure, please contact WeCo.

The safety guidelines included in this document may not include or consider all regulations in your installation/operation area. During installation and operation of this product, the installer should review and consider applicable local laws and regulations in accordance with the product's industry standards.

Installation personnel should not wear watches and other metal objects when performing installations as a precaution to avoid short circuits and personal injury.

⚠ Caution:

The weight of a single 4K4LT battery is 47 kg, please use the original packaging and take all safety precautions if the battery needs to be repositioned in another position, to avoid product damage and personal injury.

Use mechanical lifts for loading, unloading and positioning of the same.

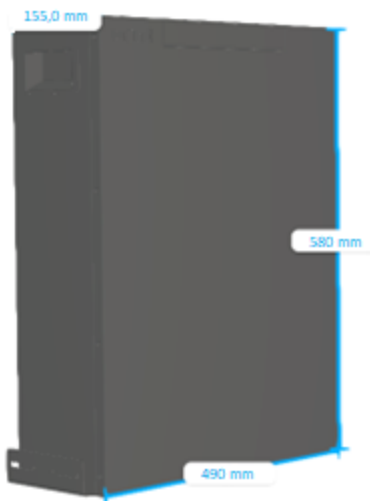

47 kg



2 PERSONS

4 PRODUCT OVERVIEW

4.1 Product Introduction

The 4K4LT series batteries can be used as an on-grid or off-grid energy storage system. It is recommended that you do not use this product for any purpose other than that intended as described in this document.

Use of this product other than that described in this document will void the product warranty. Replacement or installation of any component of this battery will void the product warranty.

The use of any component, contained in or connected to this battery, other than the products sold as part of this product or recommended by the manufacturer will void the warranty of the product.

Connecting more than eight (8) 4K4LT battery units in parallel will void the product warranty.

Overlapping of more than five (5) 4K4LT modules is not permitted.

4.2 Identification battery

4K4 LT 2023 V-1.0

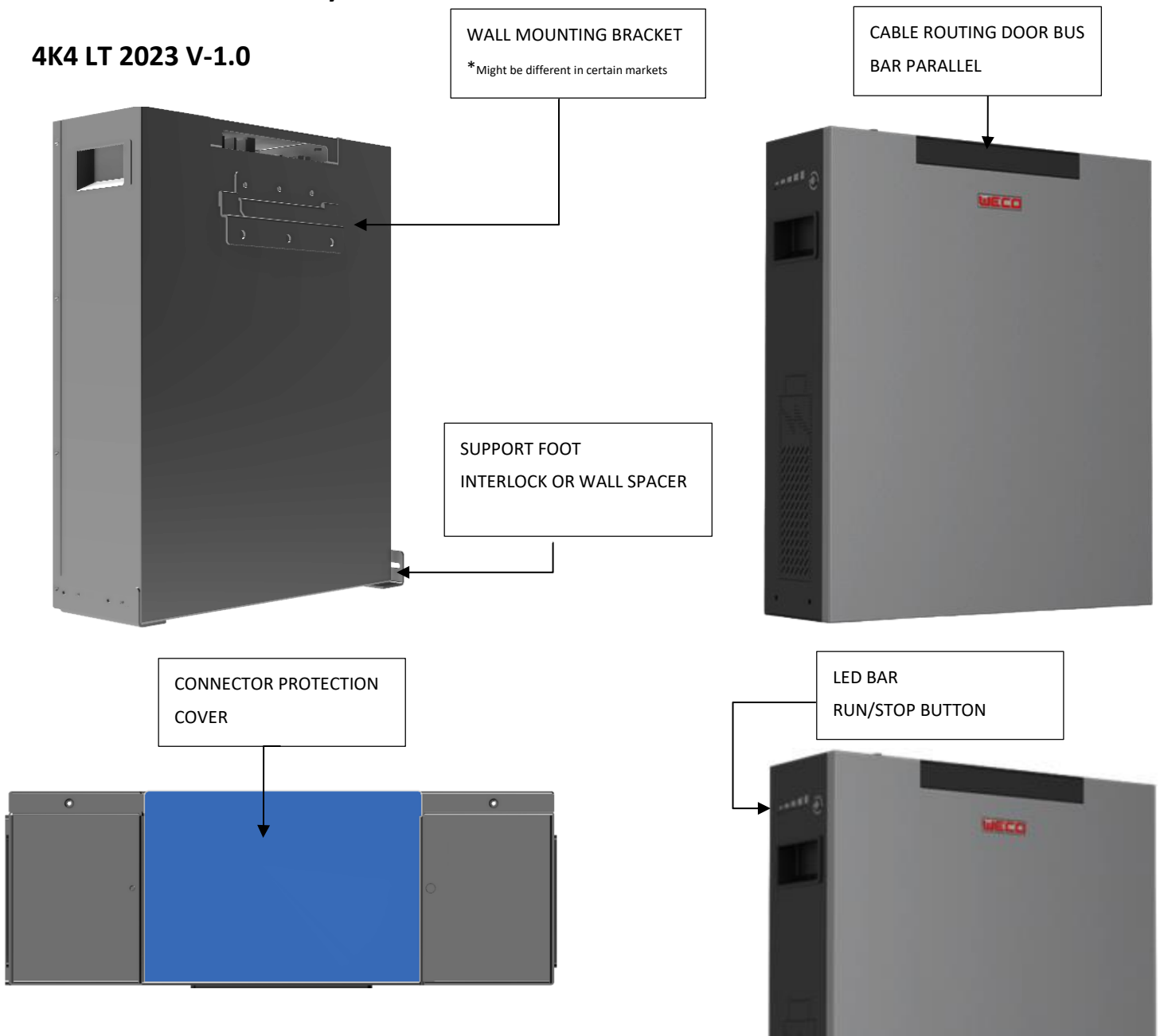

















GENERIC INFORMATION LABEL AND BATTERY SERIAL NUMBER

The label on the product plate describes the parameters of the product, including model type and serial number. Installers should always check that the specifications displayed on the battery module plate refer to the installation manual referred to for guidance.

Only qualified personnel, with complete knowledge of this manual, are authorized to install this product.

The label also shows the serial, the date of production within the serial (week / year) the production line, and the progressive serial number.

| | |
|---|--|
|   | |
| Energy Storage Systems WeCo Srl Viale Kennedy 113-121 Scarperia e San Piero CAP 50038 (FI) | |
| Emergency Number ITALY + 39 055-0357960 | www.wecobatteries.com service@wecobatteries.com |
| Modello/Model | 4k4 LT (MY 2023) |
| Capacità Utile/Net capacity @25°C | 4,4 kWh |
| Tipo Cella/Cell Type | LiFePO4 |
| Tensione Nominale/Nominal Voltage | 51.2 Vdc |
| Tensione Max Min /Max Min Voltage (BMS) UV-OV protection | 45.5-58.4Vdc |
| Utilizzo Raccomandato Garanzia/ Warranty recommended usage | 20~25°C 44A 90% DoD |
| Corrente Max Carica Scarica/Max Charge Discharge Current | -86A +86A peak |
| Range Temperatura BMS/ BMS Temperature Range | Discharge -20°C +55°C Charge -5+55°C * |
| Max N° Batterie in Parallelo/Max N° Batteries in Parallel | 8 |
| Grado IP/IP Grade | IP30 (Solo per Uso Interno/Indoor Use only) |
| Luogo Installazione/Installation Site | Indoor, ventilated, away from flammable Gas or Liquids Interno, ventilato lontano da Gas e liquidi infiammabili |
| Dimensions | 580x490x155mm |
| Peso della batteria/Weight of the battery | 47kg |
| Tipologia Batteria/Designation of Battery | IFpP/37/136/198/[16S]M/-20+60/90 |
| Standards | EN IEC 61000-6-1: 2019 EN IEC 61000-6-2: 2019 EN IEC 61000-6-3: 2021 EN IEC 61000-6-4: 2019 IEC 62619 (CB) IEC 62368 |
| Categoria Merce/Good Class | Dangerous Goods DG9 Category 3480 |
| Classificazione UN/UN Class | UN 38.3 - Lithium Ion Battery |
| BAR CODE | |
| <p>* Questo prodotto deve essere installato e mantenuto solo da operatori professionali qualificati. Leggere attentamente il Manuale di Uso Manutenzione prima di operare. Il mancato rispetto delle prescrizioni contenute nel manuale fa decadere la garanzia, la temperatura ha effetti diretti sul degrado delle prestazioni consultare le garanzie prodotto</p> <p>*This product must be installed and maintained by qualified professional installers. Read carefully User Manual before use.</p> <p>El uso e instalación inadecuados anulará la garantía. La temperatura incide directamente en el deterioro de la batería, ver garantía del producto.</p> <p>*Este producto solo debe ser instalado y mantenido por operadores profesionales cualificados. Lea atentamente el Manual de Uso y Mantenimiento y la garantía antes de operar. El incumplimiento de las instrucciones contenidas en el manual invalidará la garantía.</p> | |
|                | |
| MADE IN CHINA | |

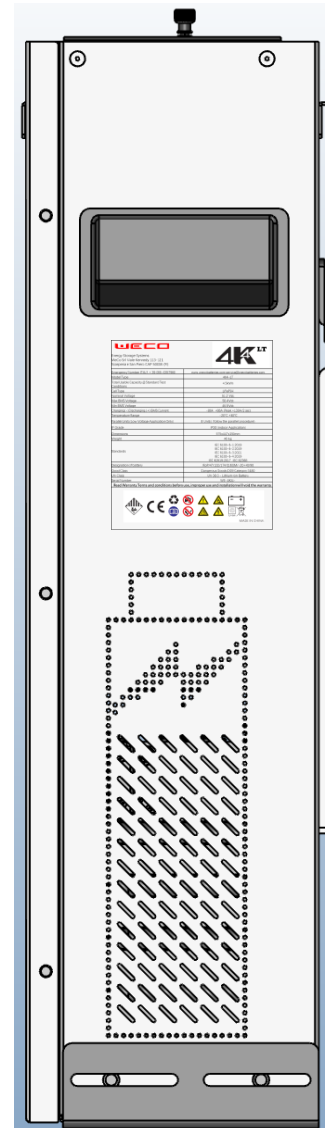

SERIAL NUMBER DEFINITION

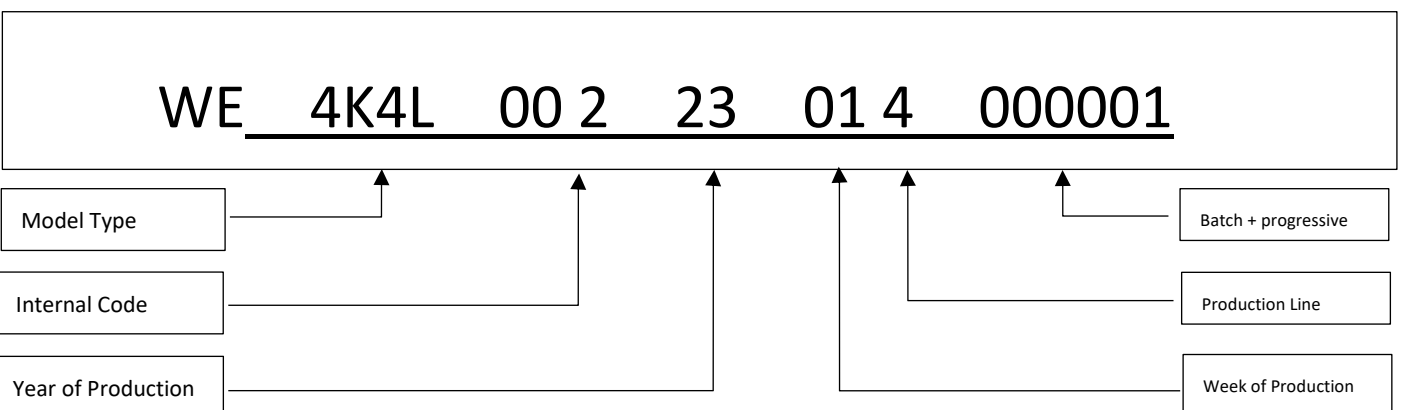

EC Declaration of Conformity (GENERIC)

The document reported here is for illustrative purposes only. The original statement is present in the battery box.



Dichiarazione di conformità



| | | | |
|---|----------------------------|---|--|
| Il sottoscritto <i>The undersigned</i> | | Marco Aiazzi | |
| In qualità di legale rappresentante della ditta WeCo S.r.l. <i>As legal representative of the company WeCo S.r.l.</i> | | | |
| con sede legale in: Viale J. F. Kennedy, 113 - 50038 - Scarperia e San Piero (FI) e Sede produttiva in: Viale J. F. Kennedy, 121 - 50038 - Scarperia e San Piero (FI) with registered office in: Viale J. F. Kennedy, 113 - 50038 - Scarperia and San Piero (FI) and Production site in: Viale J. F. Kennedy, 121 - 50038 - Scarperia e San Piero (FI) | | | |
| Partita IVA: 06567530487 VAT number: 06567530487 | | | |
| Dichiara Declares | | | |
| che il prodotto: Batteria al Litio per accumulo di energia da fonte solare <i>that the product: Lithium battery for energy storage from solar sources</i> | | | |
| Modello e codice: <i>Model and code:</i> | | 4K4LT (Low Voltage) | |
| Data Fabbricazione: vedi etichetta sul prodotto <i>Date of manufacture: see label on product</i> | | Lotto numero: vedi etichetta sul prodotto <i>Serial number: see label on product</i> | |
| È stato costruito rispettando le seguenti direttive e norme: <i>It was built in compliance with the following directives and standards:</i> | | | |
| <ul style="list-style-type: none"> • Direttiva 2014/35/UE nota come "Direttiva bassa tensione" (per gli aspetti legati al collegamento ad un sistema di ricarica) <i>Directive 2014/35/EU known as the "Low Voltage Directive" (for aspects related to connection to a recharging system)</i> • Direttiva 2014/30/UE nota come "Direttiva compatibilità elettromagnetica" <i>Directive 2014/30/EU known as the "Electromagnetic Compatibility Directive"</i> • Direttiva 2011/65/CE nota come "Direttiva RoHS" <i>Directive 2011/65/EC known as the "RoHS Directive"</i> • Direttiva delegata (UE) 2015/863 della commissione del 31 marzo 2015 recante modifica dell'allegato II della direttiva 2011/65/UE <i>Commission Delegated Directive (EU) 2015/863 of 31 March 2015 amending Annex II of Directive 2011/65/EU</i> • Direttiva 2012/19/UE nota come "RAEE" <i>Directive 2012/19/EU known as "WEEE"</i> • Direttiva 2006/66/CE relativa a pile e accumulatori e ai rifiuti di pile e accumulatori <i>Directive 2006/66/EC relating to batteries and accumulators and waste batteries and accumulators</i> • Direttiva 2013/56/UE che modifica la direttiva 2006/66/CE <i>Directive 2013/56/EU amending Directive 2006/66/EC</i> • Norma IEC 61882:2016 metodo di analisi dei rischi secondo il metodo HAZOP <i>Standard IEC 61882:2016 risk analysis method according to the HAZOP method</i> • Norma IEC 61511-1:2016 Sicurezza funzionale - Sistemi strumentati di sicurezza per il settore dell'industria di processo - Parte 1: Inquadramento e definizioni, requisiti di sistema, hardware e software <i>Standard IEC 61511-1: 2016 Functional safety - Safety instrumented systems for the process industry sector - Part 1: Framework, definitions, system, hardware and application programming requirements</i> • UNI EN ISO 7010:2021 Titolo: Segni grafici - Colori e segnali di sicurezza - Segnali di sicurezza registrati <i>UNI EN ISO 7010:2021 Title: Graphic signs - Colors and safety signs - Registered safety signs</i> • IEC/EN 62368-1 • IEC/EN 62619 • IEC/EN 61000-6-1, EN 61000-6-2, EN 61000-6-3, EN 61000-6-4 • IEC/EN 62321-2:2021, IEC/EN 62321-3-1, IEC/EN 62321-4, IEC/EN 62321-5, IEC/EN 62321-6, IEC/EN 62321-7-1, IEC/EN 62321-7-2, IEC/EN 62321-8 | | | |
| Ed è quindi conforme alle direttive e normative vigenti. <i>And it is therefore compliant with current directives and regulations.</i> | | | |
| La presente dichiarazione di conformità è rilasciata sotto la responsabilità esclusiva del fabbricante. <i>This declaration of conformity is issued under the sole responsibility of the manufacturer.</i> | | | |
| Data: | 20/12/2022 | | |
| Date: | | | |
| Luogo: | Scarperia e San Piero (FI) | | |
| Place: | | | |
| Firma: | | | |
| Signature: | | | |

GENERAL INFORMATION ON PACKAGING

Nomenclature, Use, Recycling, Category

Information about transport and storage

QTY: 1 PCS
N.W: KG
G.W: 55 KG
MEAS: 68X58.5X26 CM
This packaging is 100% recyclable

4K^{LT}
WeCo Srl
Firenze-Italia
weco@wecobatteries.com
www.wecobatteries.com

Nature of packaging and recycling information

Box Type UN / IMDG / for Goods DG
UN / C approval or says Unique.

DG9 Dangerous Goods Label
CLASS A IMDG

Product Label
Serial number and production

Product Model / Battery Type

Storage instructions and shelf goods management

Product Category DG /IMDG
Emergency number for goods DG9

Top face indications of the box

WeCo is committed to protecting the environment by using recyclable and compostable packaging.

Help the environment, reuse and recycle this packaging following the instructions of your Municipality.

REUSE BEFORE RECYCLE
THIS PACKAGING IS 100% RECYCLABLE

WeCo si impegna a proteggere l'ambiente utilizzando imballaggi riciclabili e compostabili.

Aiuta l'ambiente, riutilizza e ricicla questo imballo seguendo le indicazioni del tuo Comune.

RIUTILIZZA PRIMA DI RICICLARE
QUESTO IMBALLAGGIO È RICICLABILE AL 100%

The bags contained inside the cardboard box are produced with compostable and biodegradable materials.

They are characterized by printing as in this example.



START-UP PROCEDURE AND LED BAR LIGHT FUNCTIONS

During startup: LED1 to LED5: GREEN for 5 seconds.

After starting: LED1 up to LED5 will change color and become BLUE, at which time the battery SOC will be displayed.

STATUS OF THE SOC

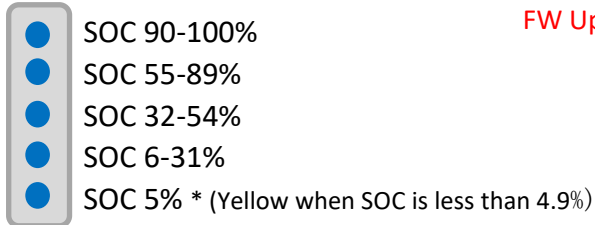

FW Upgrade

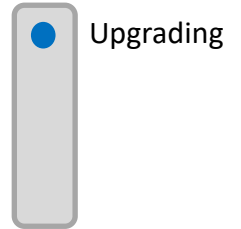

ERRORS

| Open circuit for low voltage | Open circuit for high voltage | Open circuit for low temperature | Open circuit for high temperature | Open circuit for high amperage | Loss of communication between Slave and Master | BMS in break down |
|------------------------------|-------------------------------|----------------------------------|-----------------------------------|--------------------------------|--|---------------------|
| LED1 RED | LED5 RED | LED2 RED | LED4 RED | LED3 RED | Of LED1 to LED2 RED | Of LED1 to LED5 RED |



Information:

At startup, the LED bar will light up green and then BLUE for about 5 seconds, in sequence.

During the upgrade process, only the extreme LED shown in the figure



will be illuminated throughout the upgrade process, when the battery SOC will be displayed again.

During the normal state, the LED bar always displays the SOC value.

During a failure or error, the LED bar displays the SOC value for 5 seconds, then displays the battery failure status for 5 seconds, alternately.

In the event of a permanent error, the LED bar will turn solid red.

5 SYSTEM INSTALLATION

The battery is packed in a cardboard box. The total weight exceeds 50 kg as it contains cables and fixing kits and as such it is mandatory that the handling, opening, unpacking and preliminary inspection of the battery are carried out by a minimum of two people.

5.1 Installation Notice

- a) Before installation, check the open-circuit voltage of the battery with the aid of a multimeter, the voltage must be 0Vdc.
- b) The installation site must be in an environment IP20 compatible and must be temperature controlled or the temperature must be constantly within the recommended temperatures
- c) The battery must be easily accessible in a dedicated technical room, the presence of accumulators must be reported for the Fire Department or the Police.
- d) It must be equipped with a disconnecter interposed between the inverter and the battery: the 4K4LT model is not equipped with a contactor but with MOSFET, i.e., a solid-state relay inside the BMS circuit.
- e) The external circuit breaker or fuse holder located in between the battery and inverter must be closed before turning on the battery.
- f) The place of installation of the battery must be at least 30 meters away from sources of heat, sparks or other sources of potential danger.
- g) The installation area must not be near GAS pipes or gas or gasoline powered devices and deposits of flammable liquids or gases.
- h) The battery connection cables should be as short as possible to avoid excessive voltage drops.
- i) Batteries with different capacities, different P/N or from different manufacturers should never be connected to each other.
- j) Before connecting, the positive and negative poles of the battery must be carefully checked to ensure proper installation.
- k) The battery must be installed in a horizontal plane or on a wall with appropriate characteristics and must be verified by a qualified civil engineer.
- l) If the installation is to be done in a seismic area, it is necessary to provide for a static assessment by a qualified technician.

5.2 Packaging information and parts list

The battery is packed in a box along with standard accessories. When unpacking the battery, be sure to verify that the battery and accessories are free from damage and that the correct amounts of each component are included in the box.

The following list of components can be used as a checklist when unpacking the battery and battery kits.

5.2.1 Parts list

Accessories included and accessories to be purchased separately (indicative images for illustrative purposes only).

| Number | Name | Quantity | Description | Image |
|-------------|--|----------------------------------|---|---|
| 1 | Battery | 1 | Module 4K4 LT RAL 7016 GREY | |
| 2 | Wall mount battery back plate + set screws M6 | 1 | Support plate | |
| 3 | Wall screws + bracket | set | Wall plate fixing screws + dowel | |
| 4 | Cavo CAN RJ45 (RJ 45/RJ9) | 1 | 2,5 m | |
| 5 | RJ45 parallel cable | 1 | 2,5 m | |
| 6 | Power cord | 1 | Length 2.5m 25mm diameter | |
| 7 | Manual | 1 | | https://wecobatteries.com/download-area/ |
| Accessory 1 | Bus bar | Accessory sold separately | Copper bus bar for parallel connection | |
| Accessory 2 | WiFi Dongle | Accessory sold separately | Wifi and Bluetooth for WeCo APP use | |
| Accessory 3 | Rubber insulated supports | Accessory sold separately | Rubber supports with double-sided adhesive for first stack module | |

5.2.3 Recommended Installation Tools

| | | | |
|--|--|--|---|
|  <p>Multimeter + Amperometric Clammer</p> |  <p>Screwdriver Set</p> |  <p>Set of allen and torx wrenches</p> |  <p>Drill + Hammer</p> |
|  <p>Scissors for electricians</p> |  <p>Key Sets</p> |  <p>Lifting belt + mechanical lift</p> |  <p>RS 232/USB+screw terminal (isolated) only for qualified installers</p> |

5.2.3 Personal protective equipment



5.3.1 Installation procedure (wall mounting)

Prepare the installation area considering the size and weight of the battery.

The weight of the battery is about 50 kg. The wall or floor must be able to support the weight of the battery.

Wall installation procedure

Step 1: Install the fixing screws on the appropriate wall height.

⚠ Information:

When installing screws, please check the size of the wall plug, WeCo provides 4x $\phi 10 \times 60$ mm, but you may need a different size or type depending on the actual installation surface.

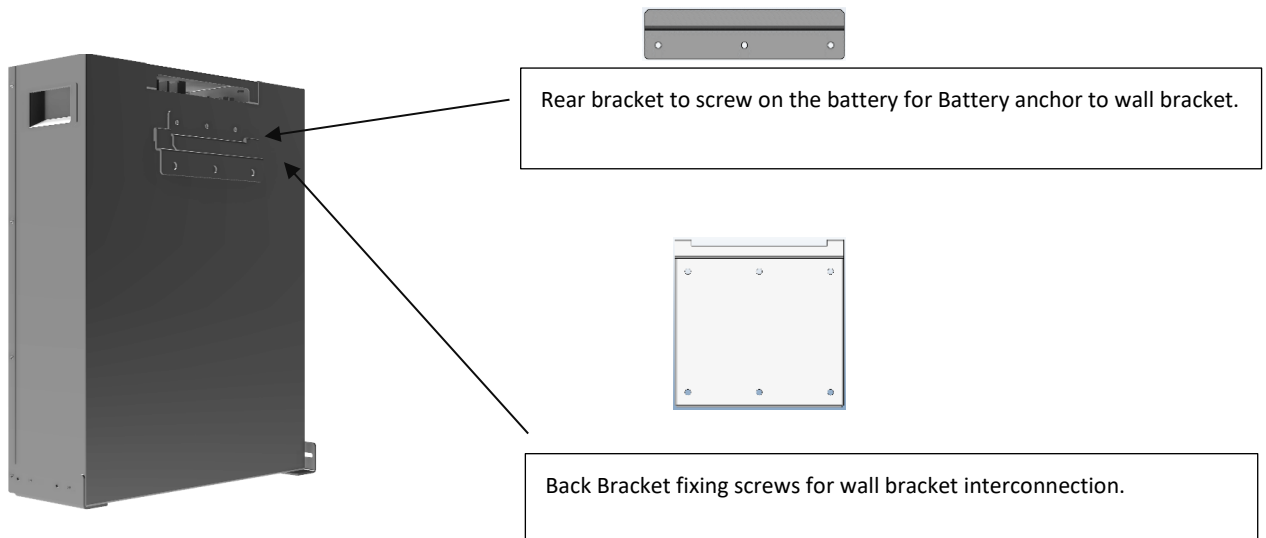

Step 2: Make sure the mounting screws are securely attached to the wall.

⚠ Information:

When the battery bracket has been secured, please work with a partner and install the battery on the wall bracket, in order to avoid personal injury or damage to the product.

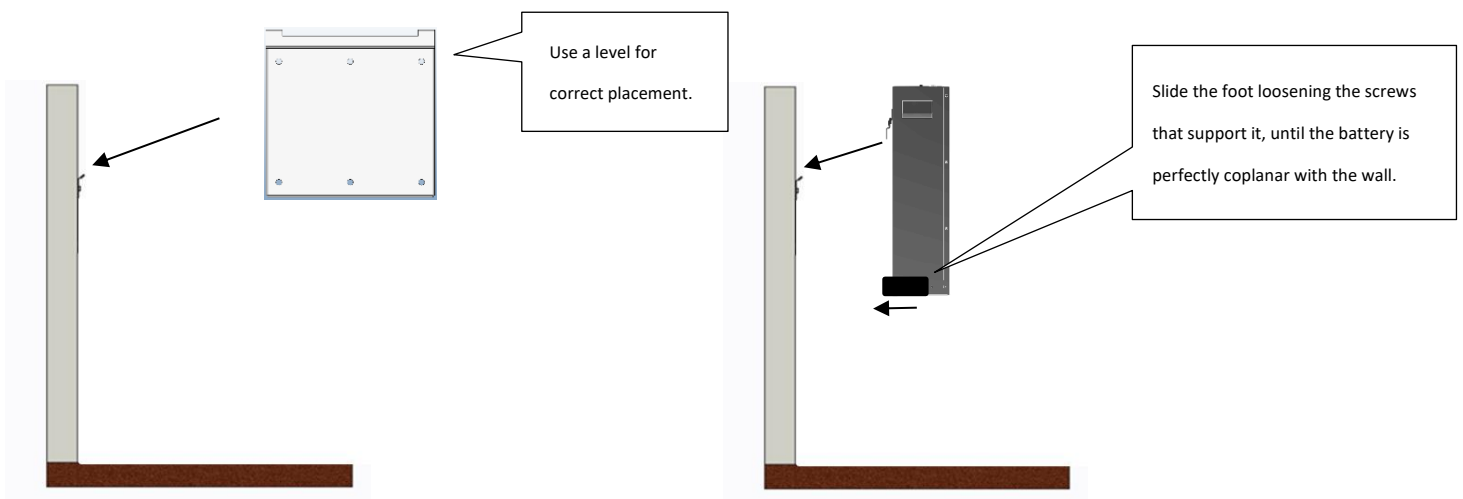

Step 3: Attach the support plate to the wall.

Step 4: Attach the battery module to the wall bracket.



Information:

For wall and floor installation it is always necessary to fix the battery module with the vertical structure using the supplied bracket. Self-supporting installations are strictly prohibited.

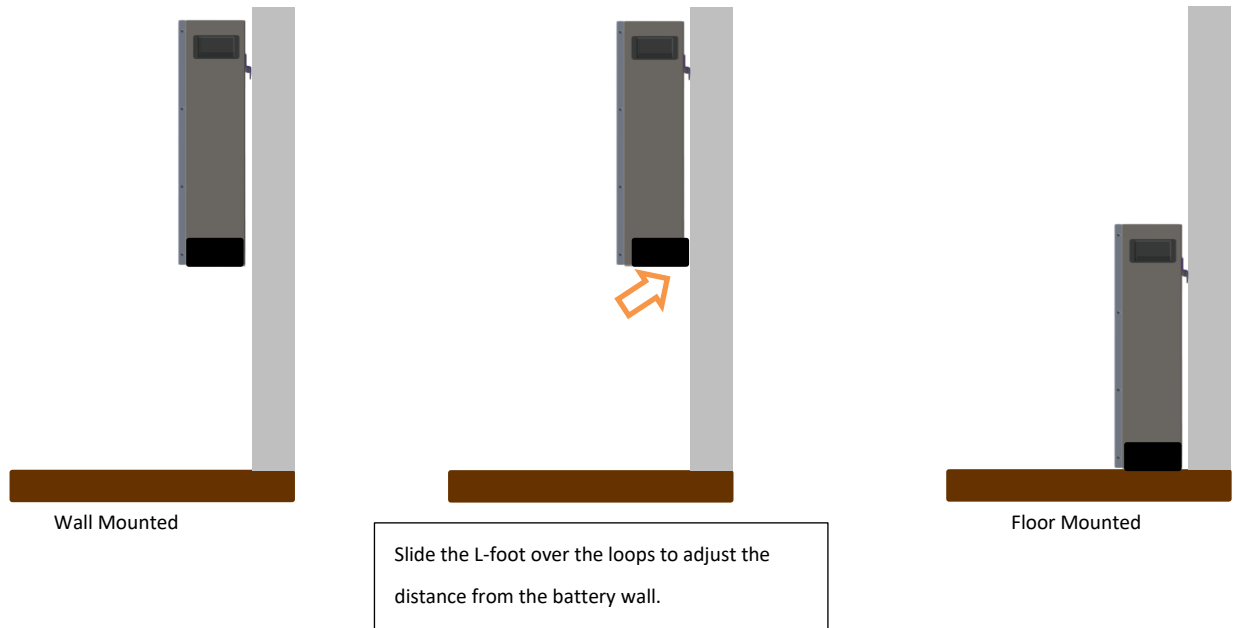

Information:

When installing the battery, please work with appropriate lifting devices operated by at least two people to avoid personal injury or damage to the product. The battery module weighs about 50 kg.

Wall mounting of multiple batteries

Keep 20 cm between batteries and/or between walls (side) and other objects on the left and right side.

Keep at least 40 cm from the ceiling.

The underside of the battery is recommended both at least 100 cm from the floor for easier maintenance.

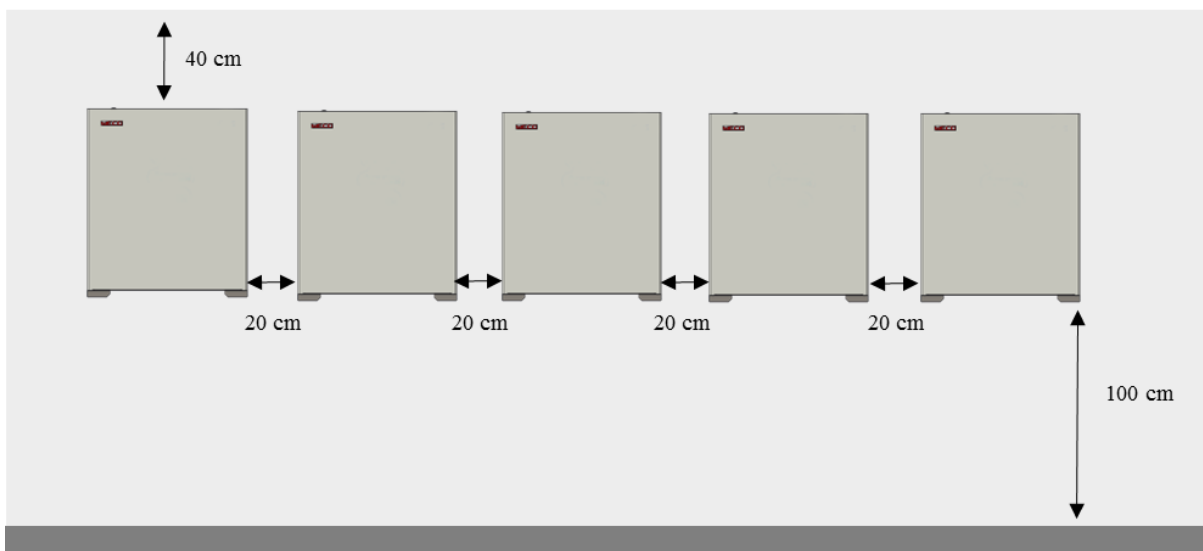

5.3.2 Installation of the floor tower

5.3.2.1 Installation of accessories and preparatory steps

Step 1: Choose your table top carefully: the batteries weigh about 50 kg each and a tower of five batteries can reach 270 kg including accessories.

Ensure that the support surface is adequate to support the overall battery load.

The maximum number of stackable units is five (5).

! Information:
Preparation of modules

The batteries are supplied as standard in **wall configuration**, and it is therefore necessary that the installer makes simple external changes to install them in **STACKABLE CONFIGURATION**.

INSTALLATION PROCEDURE IN STACKABLE CONFIGURATION

Step 1: If the batteries are to be stacked, the rear bracket will not need to be installed.

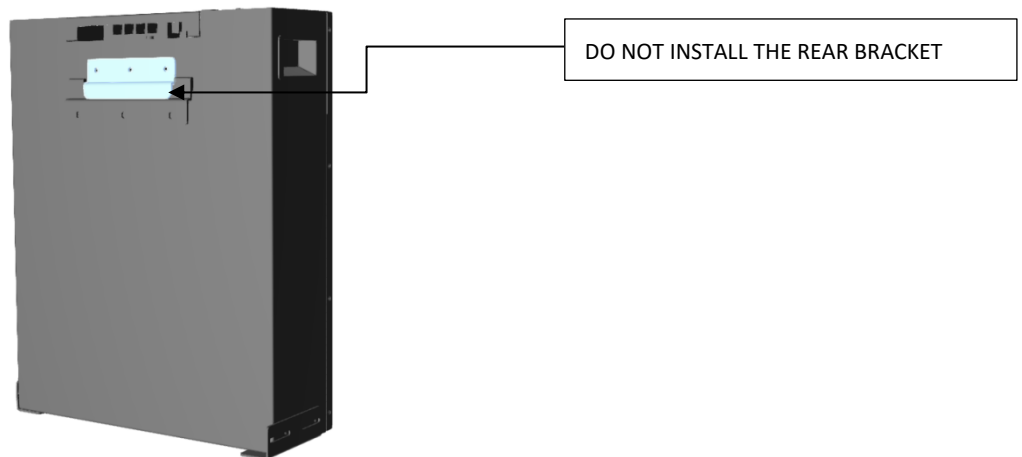

! Information:

For stacked installations (STACK) do not install any bracket or screw on the back of the batteries.

The rear surface must be free from any object otherwise it could damage the underlying battery or be a hindrance due to the possible passage of cables in the space between the floor and the lower part of the first battery.

Step 2: Place the first module on an insulated support (rubber support kit not included and to be purchased separately).

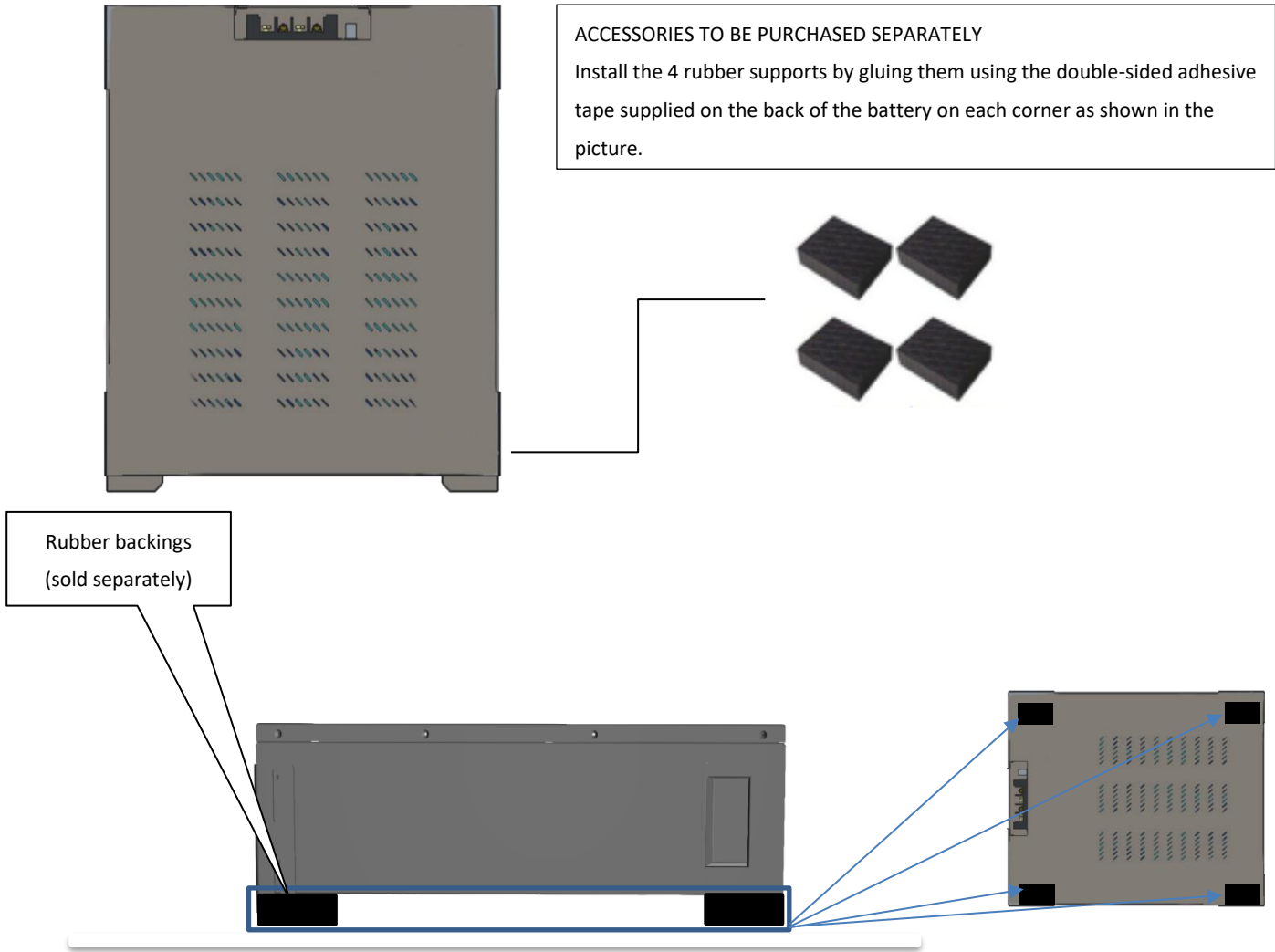

⚠ Notice:

Place the first module with the supports on the floor in accordance with local regulations and in accordance with the structural specifications of the site.

Step 3: Loosen and place the second battery on top of the first that is already installed on the floor. The following will then be removed and used to interlock one module to another.

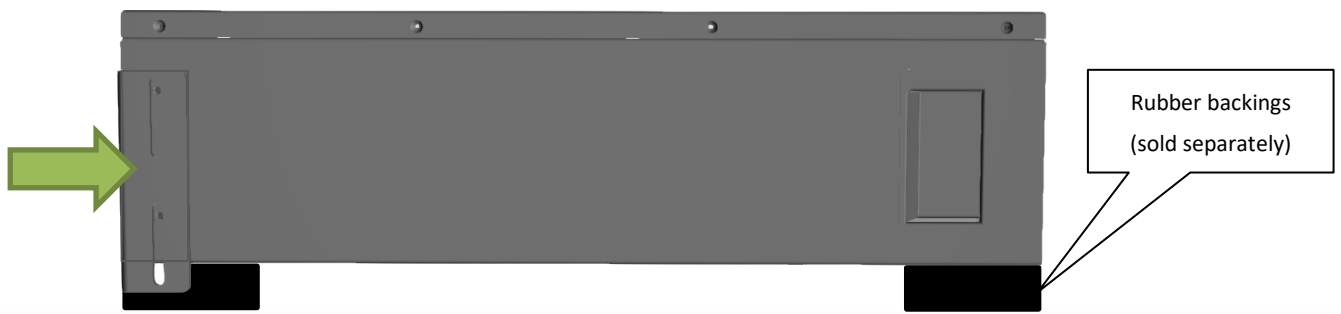

Step 3.a: Lift and place the second battery on top of the first already installed on the floor on its rubber feet.



Step 4: Once each battery has been installed horizontally, the feet supplied with the battery in standard configuration can be removed and installed through the modules to constrain the modules on both sides.

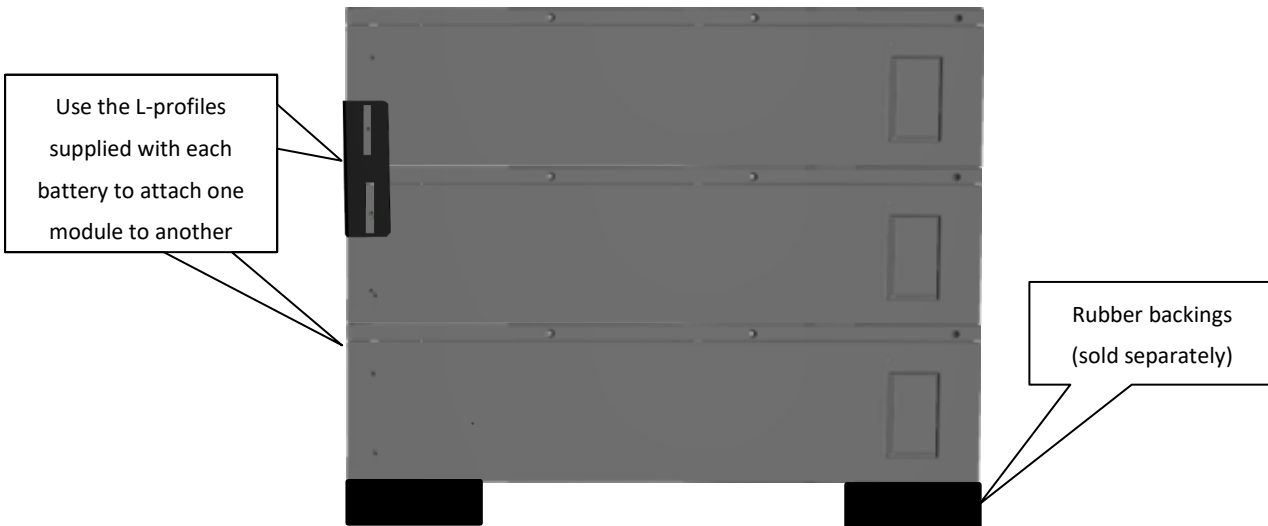

⚠ Caution:

Each battery weighs about 50 kg and must be installed with the aid of a mechanical lift, and/or with at least two people equipped with suitable suction cups for lifting or with lifting belts.

At this point you can proceed with the wiring.

INSTALL BAR BUS AND RS-485 RJ45 COMMUNICATION CABLE

To allow cables or bus bars to pass from one battery to another, the front protection highlighted below must be removed.

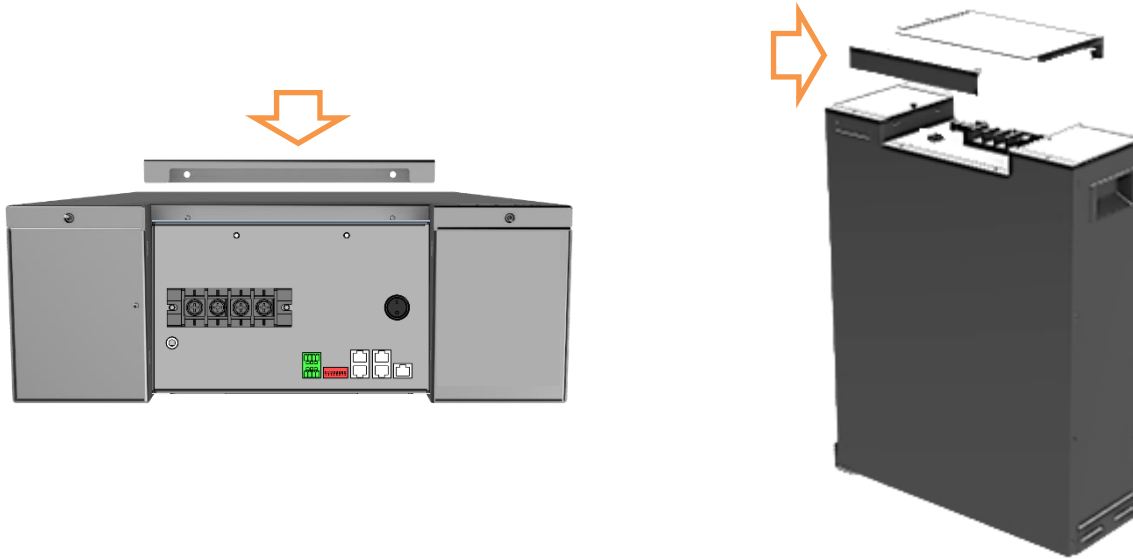

INSTALL BUS BAR MODEL 4K4LT (**Accessory not included**) ON THE TERMINAL LV BLOCK or properly prepared cables

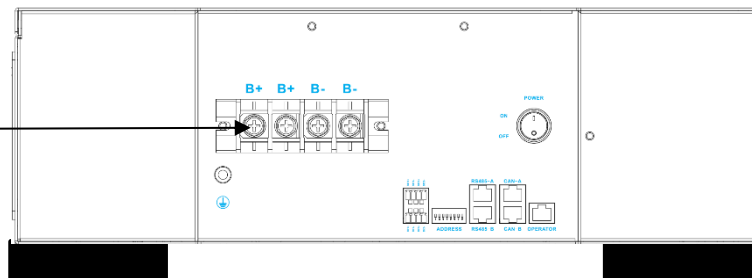

⚠ Caution:

MAKE SURE THAT **THERE IS ZERO VOLTAGE ON THE BATTERY TERMINALS**. CHECK THE LED BUTTON AT THE BOTTOM AND ALWAYS MEASURE THE B+ AND B- TERMINALS WITH A MULTIMETER.

Once you have verified that there is ZERO-volt present ON ALL BATTERIES, proceed with the installation of cables or bar buses (as shown in the example below).

EXAMPLE of connection to the power supply through the STACKABLE BAR BUS KIT and cluster composed of 2 TOWERS 4 + 4).

Always install cables in accordance with installation guidelines and do not use particularly long cables to avoid excessive voltage drops

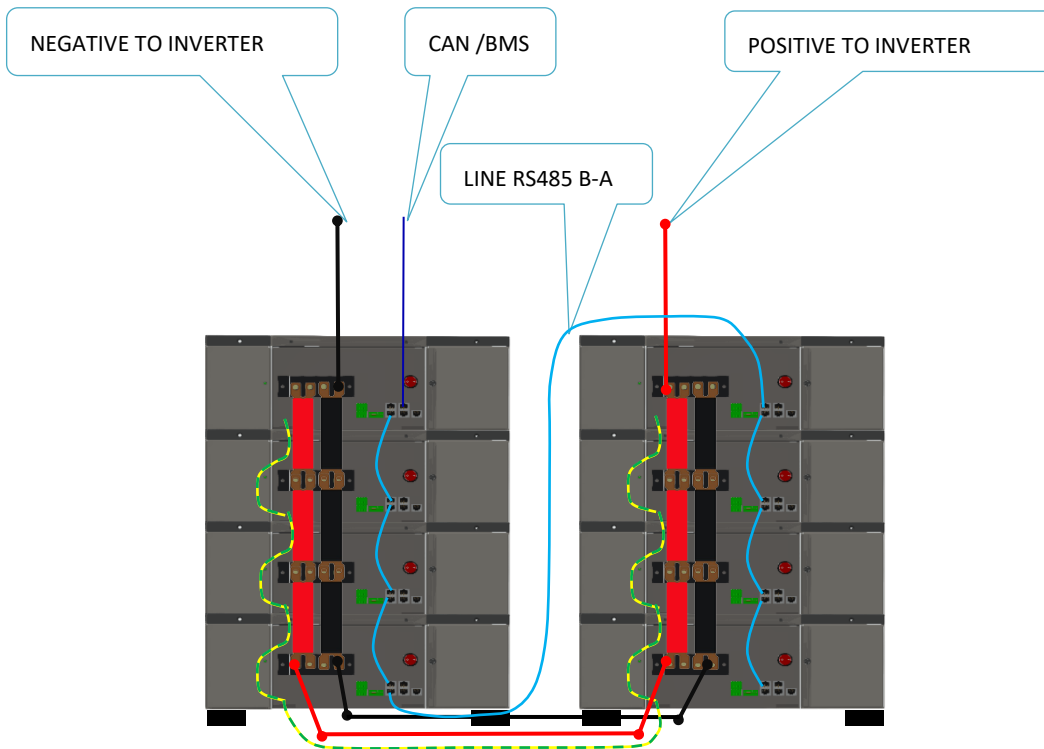

After all cables and bar buses have been connected and the inverter has been set correctly, place the rocker switches (see section 5.4) of all batteries on ON (I). Try to start the system by turning on only the master module: if the installation is set correctly all modules will turn on in sequence.

Reassemble the protective front plate to protect the power and communication terminals.

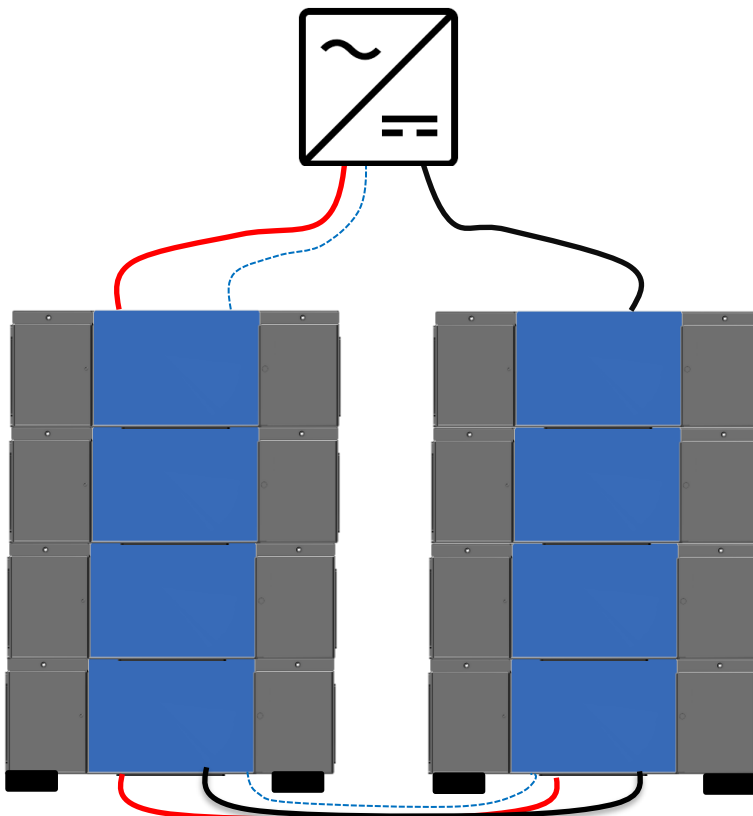



Attention: Screws, Cables and Bars POWER CONNECTIONS on the battery terminal block must be installed with due diligence and the tightening of the connection terminal must be in accordance with the TABLE OF CUTTING TORQUES of this section.

Each terminal must be inspected and its pair checked every three months.



Fixing pair

| Screw diameter (ISO) | Maximum fixing torque | Application | Construction Applied torque |
|----------------------|-----------------------|--|-----------------------------|
| Code | [Nm] | | [Nm] |
| M3 · | 1.7 | BMS protection cover | 1,2 |
| M4 · | 3.8 | External covers | 3 |
| M5 · | 7.5 | Isolators and contactor support | 7 |
| M6 · | 10 | Fuses, Cables, Connection to terminals / feet / brackets / wall sockets | 6 |
| M8 · | 14 | Steel plastic and cables on terminal block / feet / brackets / dowels | 13 |
| M8 · | 32 | Connection steel on steel / steel to copper / contactor terminal to bus bar) | 16 |
| M10 · | 62 | External Bus Bar (Aluminum and Copper) steel fitting on steel | 40 |
| M12 · | 107 | External connections, copper-copper joints | 60 |

ATTENTION

Tightening torque refers to the use of a single standard bus bar or cable lug terminal; if using several overlapping or non-standard bus bars/terminals, check screw length \geq 16mm.

If during the quarterly check the screws have a residual torque lower than these values, it means that the cables and / or the bar are subjected to out-of-flow currents, as the thermal effect helps to loosen the screws / bolts.

ATTENTION

During the quarterly check, make sure that the START and STOP phases are functioning correctly.
 Clean the RJ45 ports and clean the side louvers for ventilation.
 Check the correct functioning of all RS485 and CAN communication devices.

5.4 Communication and control panel

5.4.1 Function and definition of the terminal

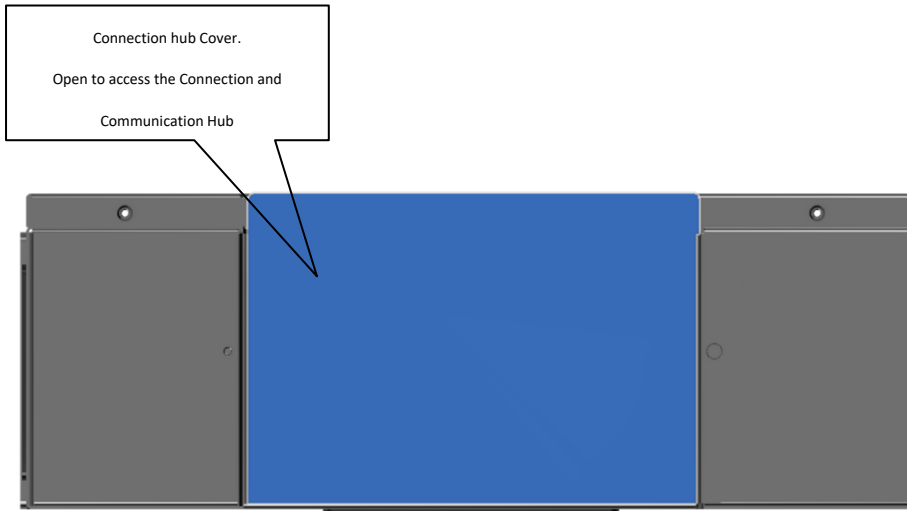

The terminal layout is shown in the following figure:

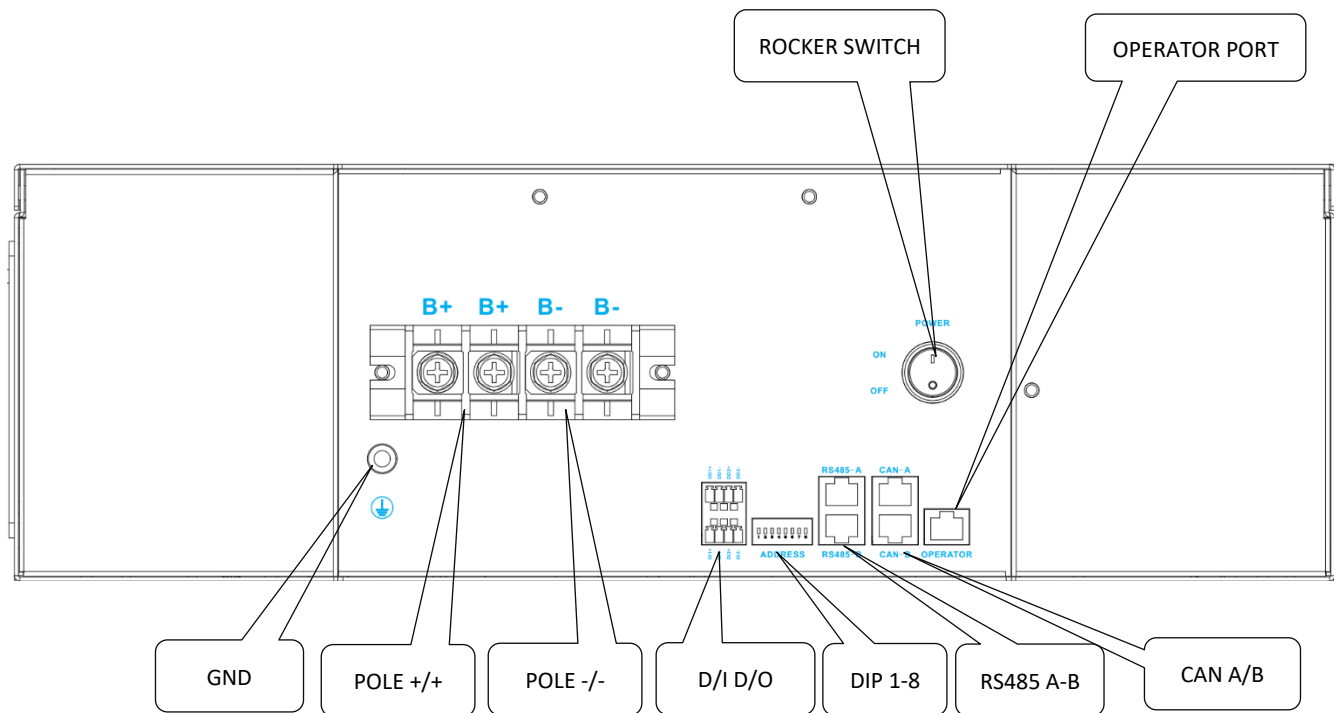

| | | |
|---------------|-----------------------|---|
| DI/DO | 2 Inputs + 2 Outputs | Programmable contacts for external devices such as Generator Start Stop |
| CANE | Linea CAN | External communication line IN/OUT to Inverter |
| CAN2 | Linea CAN | Internal IN/OUT communication line to other master batteries (Clustering) |
| DIP | BLOCCO DIP SWITCH 1-8 | DIP for termination and addressing |
| RS485A | Parallel line RS485 | RS 485 port for Daisy Chain modules connection in parallel |
| RS485B | Parallel line RS485 | RS 485 port for Daisy Chain modules connection in parallel |
| Positive POLE | Screw terminal | 2 X positive |
| Negative POLE | Screw terminal | 2 X negative |

Internal Layout.

(Do not open the lid so as not to lose the right to the warranty)

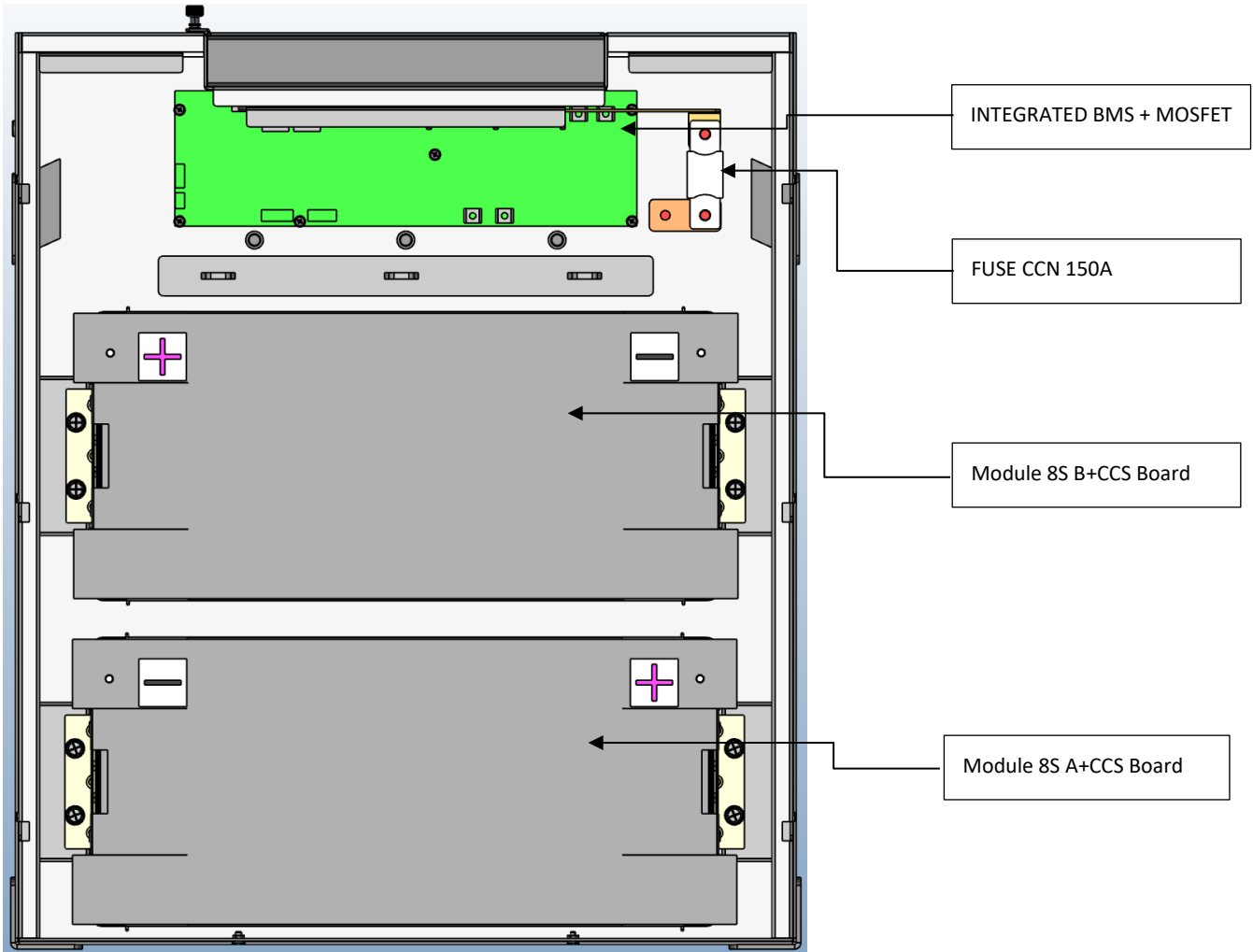

Attention: The BMS CAN interface is an RJ45 port with the definition of the CAN Bus pins as shown below

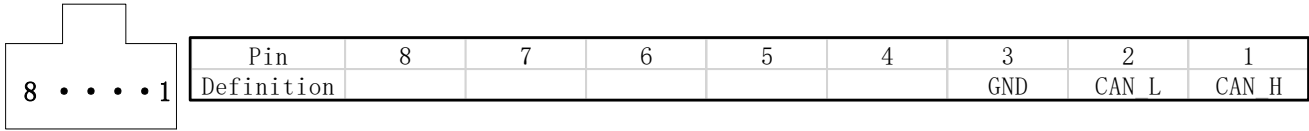

5.5 DIP Switch Block Settings

ON
OFF

DIP SWITCH SETTING FROM FIRST TO PENULTIMATE MODULE 00000000 (ALL OFF)

ON
OFF

SETTING DIP SWITCH LAST MODULE 00000100 (DIP 6 ON)

ATTENTION

- ⚠ Caution:**
Always configure the DIP switch settings BEFORE connecting the power cables to the B+ and B- battery terminals.
- ⚠ Caution:**
The battery module must be restarted for the DIP switch settings to take effect.
- ⚠ Caution:**
When connecting to an inverter that has BMS-CAN communication, switch #5 on the master battery module should always be set to "ON".

5.6 Parallel battery wiring convention



Caution:

Parallel battery installation must follow the wiring conventions shown in the illustrations in this section.

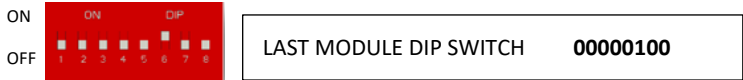
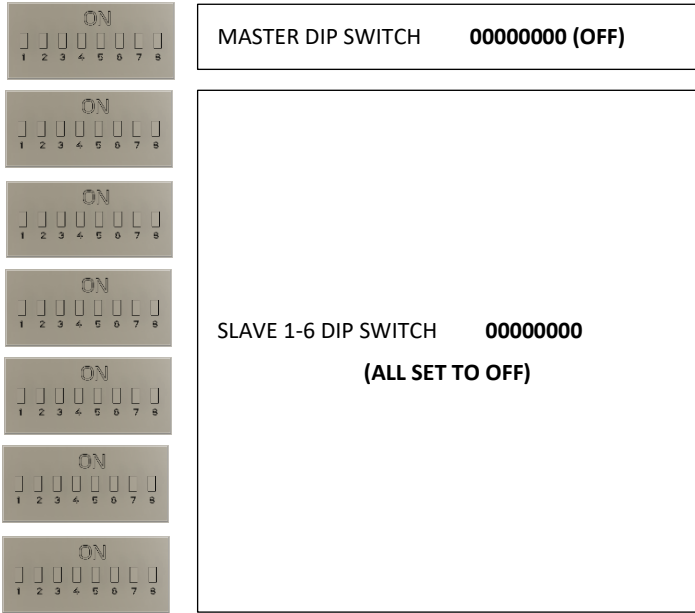

ATTENTION IMPORTANT NOTE

- DIP switches must be set with the battery off.
- The RS485 cables must be installed in sequence starting from the RS485 B Master Port battery and continuing to the RS485A port of the first Slave module.
- RS485 communication cables must be installed with batteries off.
- In case of incorrect installation of RS485 cables and / or incorrect setting of DIP switches it will be necessary to turn off all batteries manually and correct the configuration/setting and repeat the power sequence (see following pages).

SINGLE BATTERY WIRING

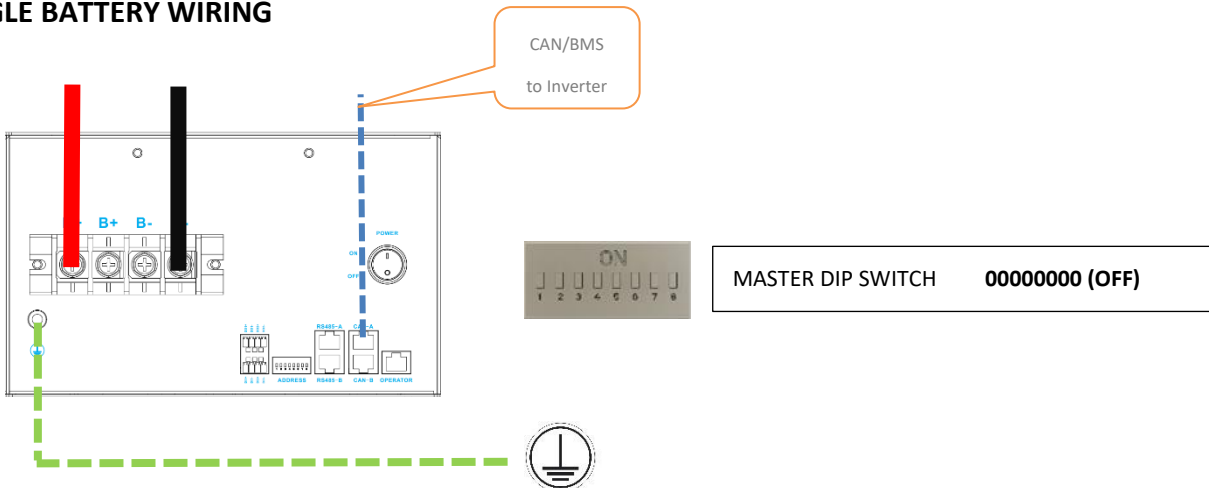

5.6.1 Master + Slave 1

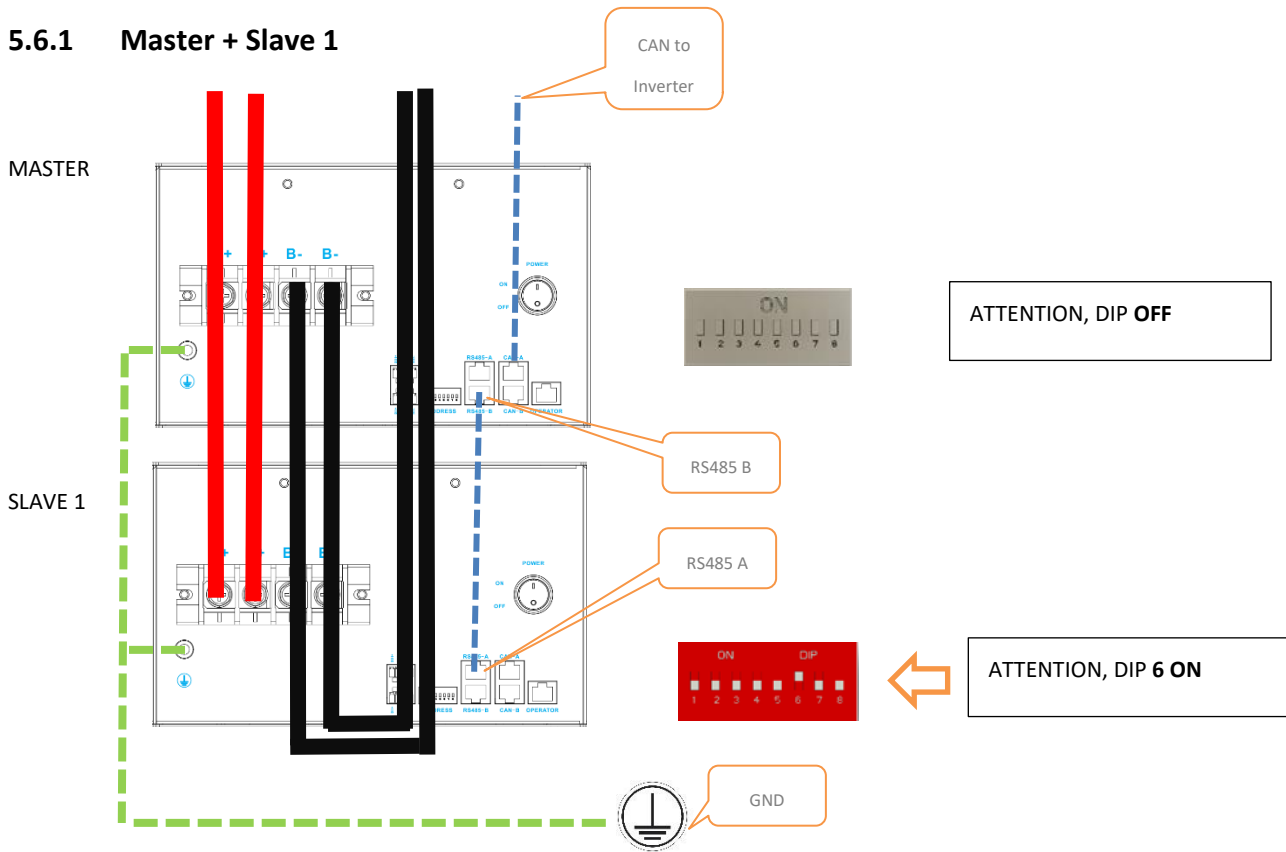

5.6.2 Master + Slaves from 1 a n * (MAX 8 MODULE)

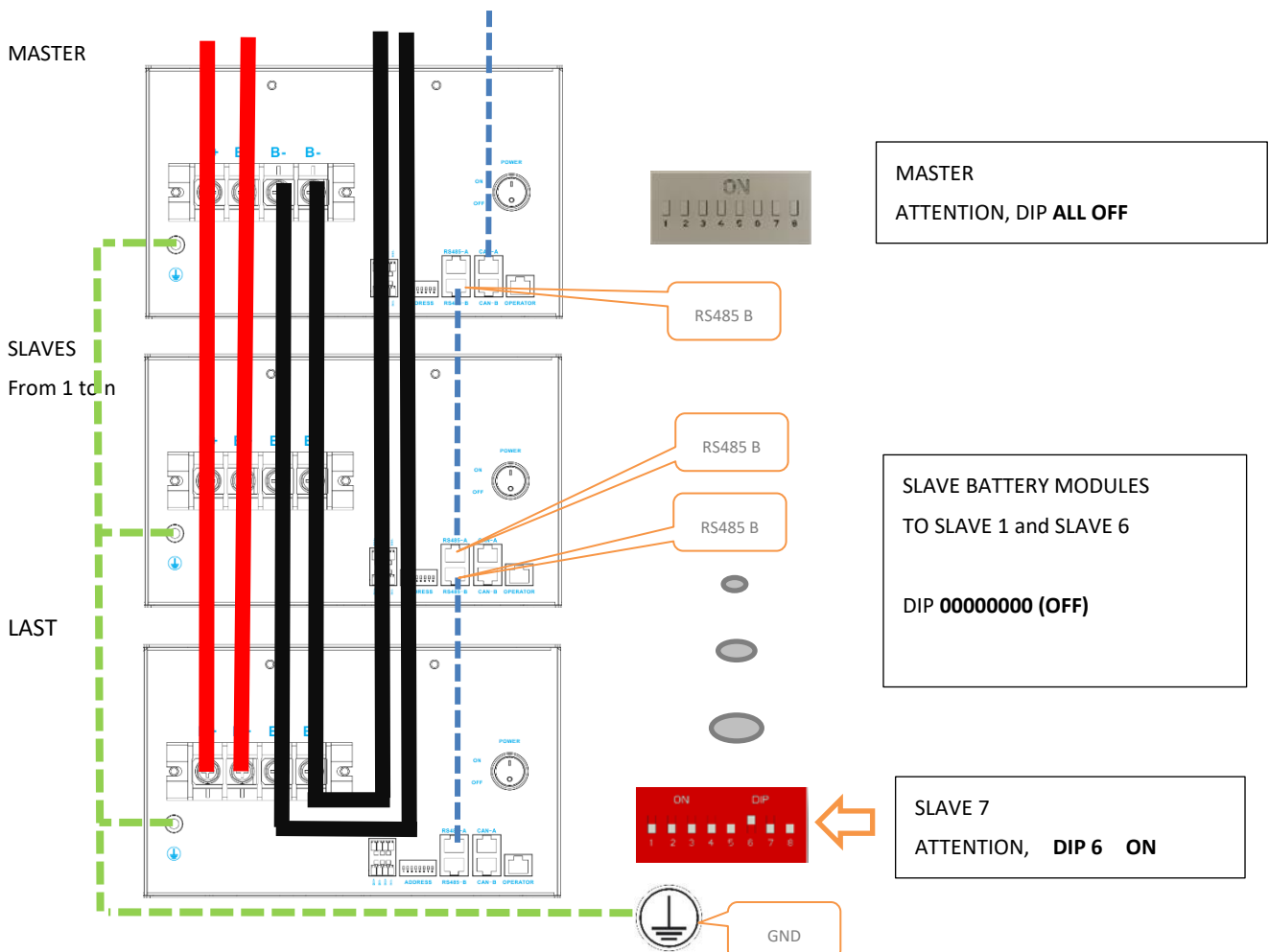

6 BATTERY ACTIVATION AND SHUTDOWN

6.1 Panel buttons and LED explanation

Warning: The drawings in this manual are for reference only.

BMS Power Switch (rocker switch), may be located on the right shoulder of the battery next to the RUN button or under the connector or recover door near the OPERATOR PORT RJ45.



RUN/STOP button, The power button may be on the top or side of the battery.



| Name | Meaning | Status of function or indication |
|---------------|---|---|
| Rocker Switch | BMS Power | Turn the BMS module on or off |
| RUN-STOP | Ignition phase trigger | Turn the battery on or off (power) |
| START-RUN | Flashes green when the battery module starts | When the battery starts normally, it flashes for 5 seconds |
| FUNCTION | Solid green when the battery module is operating normally | When the battery is working normally, the power button will remain solid green |
| STOP-OFF | It turns off with the pressure of 5 seconds. | By pressing the RUN button for 5 seconds the battery will be turned off (LED light off) |

6.2 Stand-alone battery front control panel

6.2.1 Initiation of the battery

Briefly press the power button for 1-2 seconds. The green light of the power button flashes.

The battery has been activated normally and the circuit is closed when the green light of the LED becomes fixed.

6.2.2 Turn off the battery.

Long press the power button for 3-5 seconds.

The green light of the power button turns off.

The battery was turned off normally.

6.3 Starting a parallel system consisting of multiple batteries (Cluster LV).

1. The voltage difference between any of the batteries in the stack should not be more than 2V. Otherwise, the BMS will not allow the batteries to be activated in a parallel connection.
2. The power wiring between the batteries must comply with manual. Reversing polarity will cause irreparable damage to the battery.
3. Battery DIP switches must be configured with the batteries turned off and must follow the instructions in the manual. The last module must have the **DIP 6 ON (00000100)**.
4. **The power wiring between the battery and inverter must be executed using the J-Loop method (Master battery positive output cable to the inverter / from the slave, negative power cable to be connected from the negative**
5. RS 485 data connections by means of RJ45 cables between batteries must be made correctly as indicated in this manual. The cascaded RS485 data connection must start from port B of the master battery and continue in RS485-A RS485-B sequence to the last battery.
6. Connect the CAN port of the **master battery** with the CAN port of the inverter and make sure that the communication is working properly by controlling the inverter display or APP.
7. Before activating the system, the operator must carefully check the power connection and ensure that all safety procedures are adhered to.
8. Activate all rocker switches (BMS switch) by setting them to I (ON).
9. Press the RUN button of the Master battery only for 2-5 seconds.
10. Wait for all SLAVES to turn on automatically. In case of error the LED bar of the specific battery will indicate an anomaly (see indications LED bar in this Manual).

6.3.1 Turning off parallel batteries

Press the power button of the master battery for five seconds. The green light of the power button turns off immediately.

The green lights of the power buttons of the slave batteries will not turn off immediately but will flash for an additional 30-120 seconds in case of connection to WiFi module being updated.

In any case, wait for the slave batteries to be completely switched off.

The RED LED lights of the LED bar on the slave batteries will start flashing to confirm that the shutdown has been turned off.

The battery shutdown takes place immediately when the Master battery is turned off, as the MOSFET (Solid State Relay) open within 3 seconds, while the BAR LEDs remain active for a further 10 seconds, and then turn off at the same time as the RUN/STOP button.

The parallel battery system will only have turned off properly when the power button light has gone out.

To turn off the batteries completely and switch off the BMS, you must also turn off the rocker switch of the BMS setting it to 0 (OFF)

Check with a multimeter whether there is voltage at the battery poles. In case of voltage, it will be necessary to check the entire system, as one or more batteries may have been damaged.

Notice:

In a parallel battery system, it is not allowed to switch off individual slave batteries.

If there is a reason to turn off a slave battery, it is still recommended to turn off the master and the inverter anyway.

In case of voluntary shutdown of a slave battery, in order to restart the cluster, it will FIRST be necessary to turn off all the batteries and proceed to a new automatic start, as described in the procedure in point 6.3 of this manual.

 **Caution:**

DC CIRCUIT SECTIONING

WeCo recommends the installation of a bipolar disconnector for direct current interposed between the battery or several batteries and inverters.

In some countries it is mandatory, so it is not possible in this manual to give detailed indications to define the type and standard of this device. It is required that the installer and the design technician work to verify the local regulations and the sizing of the disconnector to be used according to the power of the inverter.

In case of need, it is still possible to contact WeCo by writing to service@wecobatteries.com.

 **Caution:**

PRE-CHARGE CIRCUIT AND START-UP PRECAUTIONS

The batteries are equipped with a pre-charge circuit to protect the power circuit of the inverter.

During the ignition phase of the batteries the disconnectors installed between the battery and the inverter **must be closed**, otherwise, the pre-charging function will be ineffective in the open circuit.

The inverter and batteries may be damaged if the disconnectors are closed after the batteries are turned on.

Turning On the batteries before having the circuit breaker closed might cause hardware damage due to the inrush current

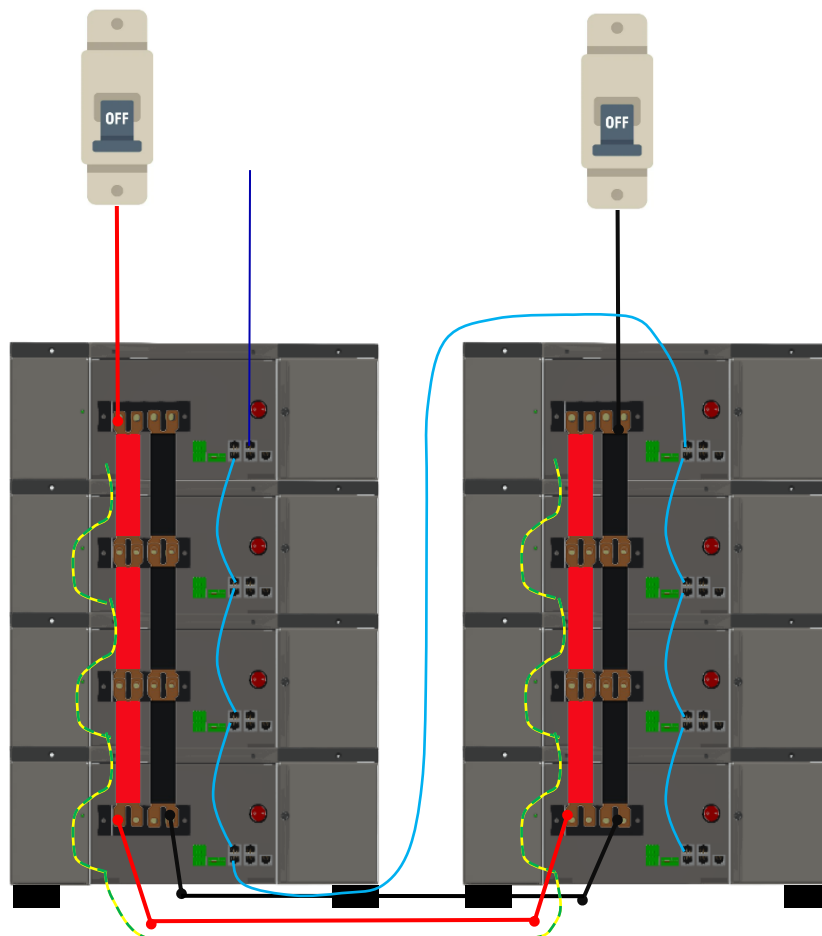

7 CAN HUB XP MODEL

Required for installations of more than 1 cluster.

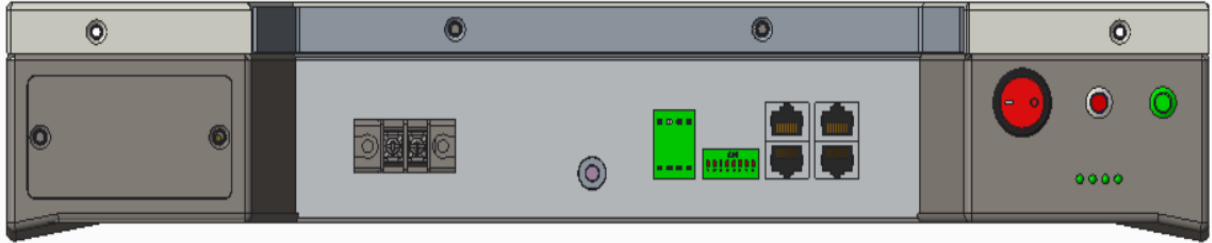

LOW VOLTAGE HUB-XP



The use of this device is mandatory when multiple clusters are connected to a common bar bus.



Each battery pack and cluster must have the same voltage and firmware.

All stack configurations must use the WeCo Bus Bar up to max 300Adc.

Each cluster must have the same number of battery packs with the same firmware.



The HUB works only with WECO approved inverters and only via CAN BMS.



For more detailed information on the use and connections of the HUB consult the specific manual.

6.4 Low battery - Force Charge

Prerequisite: The **VOLTAGE** between the battery terminals B+ and B- is **ZERO** and the **LIGHTS OF THE LED BAR ARE OFF**.

The battery is off and does not react to any startup action.

Preparation conditions before forced charging: Connect the charger or inverter with charging capability to the B+ and B- terminals of the battery to ensure charging.

Forced charging approach:

Disconnect the batteries if in parallel and use them individually.

Set DIPs as Master 00000000.

Activate the Switch rocker (1) short press the battery power button, the battery RUN light will flash green.

The LED Bar will indicate the status of LOW SOC (only one red LED On).

If the RUN button flashes, the battery is entering force charging mode.

If the battery receives adequate charging power (greater than 5 Ampere/58 V) within 180 seconds of pressing the RUN button, the battery will continue to charge normally.

If the battery does not receive adequate charging power within 180 seconds of pressing the button, the battery will enter shutdown mode again to avoid the self-discharge condition.

ATTENTION:

If the LED bar shows all the red LEDs, the battery cannot be charged.

If the LED bar and the RUN button do not light up, it means that the battery is in a state of excessive discharge and must be sent for service.

8 Utilize Dongle APP WiFi – Bluetooth

The 4K4LT battery can be equipped with an external dongle with WiFi and Bluetooth function.

The Dongle is supplied as an accessory and can be used through the two APPs made available by WeCo, downloadable from APPLE STORE and GOOGLE PLAY.

The WiFi Dongle connects, via the supplied RJ45 cable, to the OPERATOR port of the battery. In the presence of multiple batteries in parallel, simply install it on the MASTER battery and through the WiFi APP it will be possible to monitor all the batteries, both the MASTER and the SLAVE.

In the case of using BLUETOOTH APP instead, the data received will be limited to the battery to which the Dongle is connected, as this APP is designed for Debugging operations carried out by installers. The dongle can be connected on each of the beats and the cluster simply by detaching it from the Master and connecting it to each battery you want to monitor.

The data transmitted via Bluetooth are instantaneous data and are not historicized by the APP.

To use the Dongle simply connect it to the OPERATOR PORT and turn on the battery.

Download the APP and follow the directions to WiFi and Bluetooth available in the download area of the site www.wecobatteries.com.

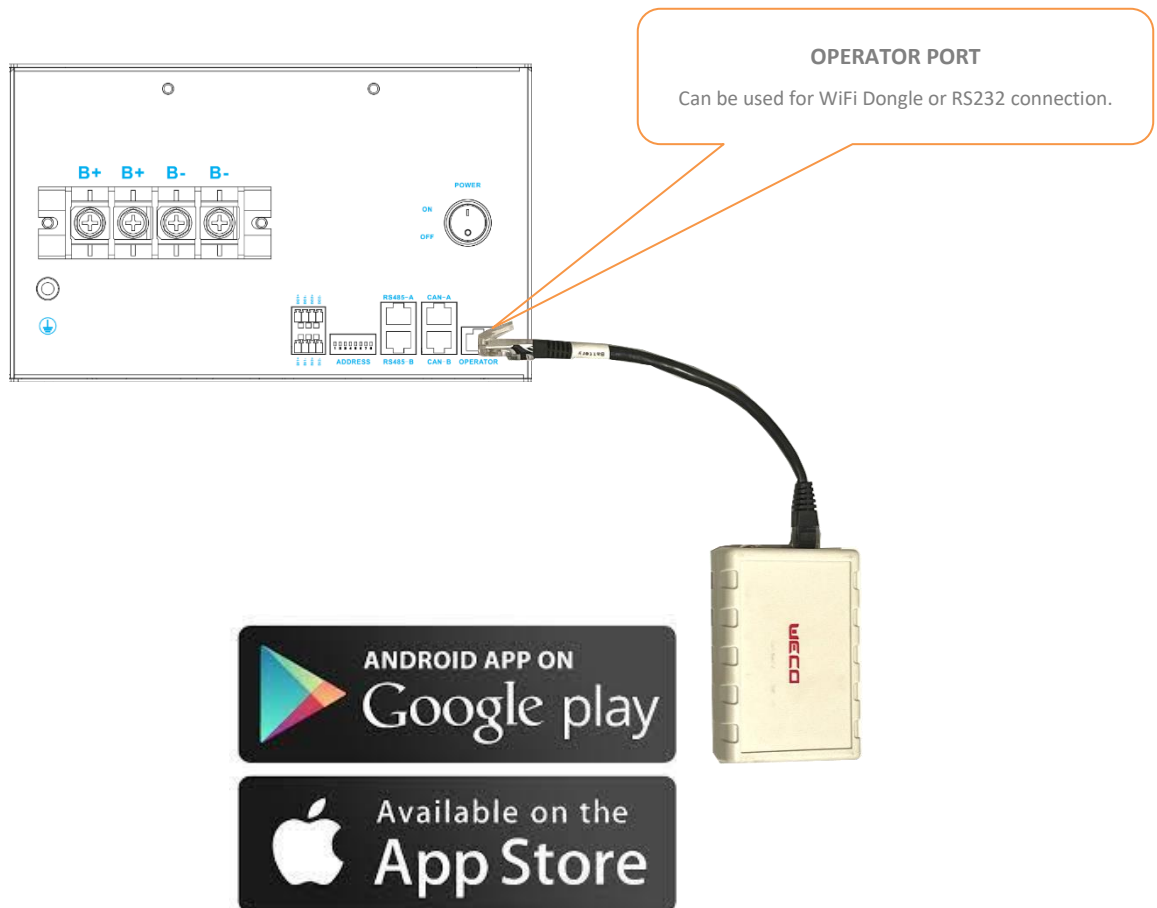

9 DRY CONTACTS SETTINGS

The battery is equipped with dry contacts that allows to interact with external devices other than the inverter to which they are connected. These contacts, indicated as DO1+/DO1- and DO2+/DO2-, are accessible via the green connector located next to the battery DIP switches.

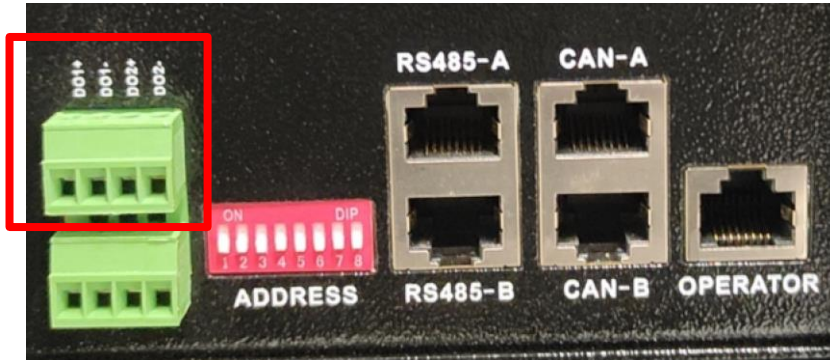

Using the PC software, you can define dry contact activation thresholds based on the % SoC value of the battery. After connecting to the battery with the software using the installer password, simply go to the DO Setting page.

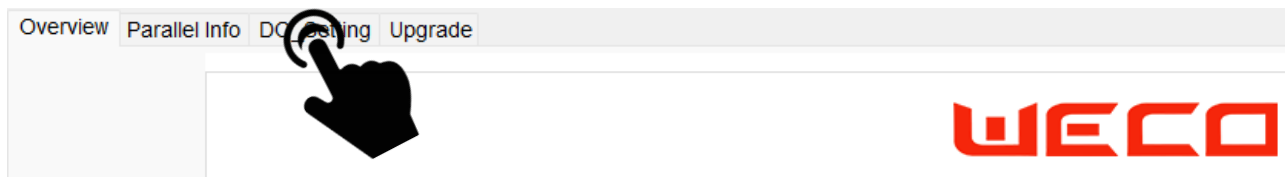

to display the DO Setting section.

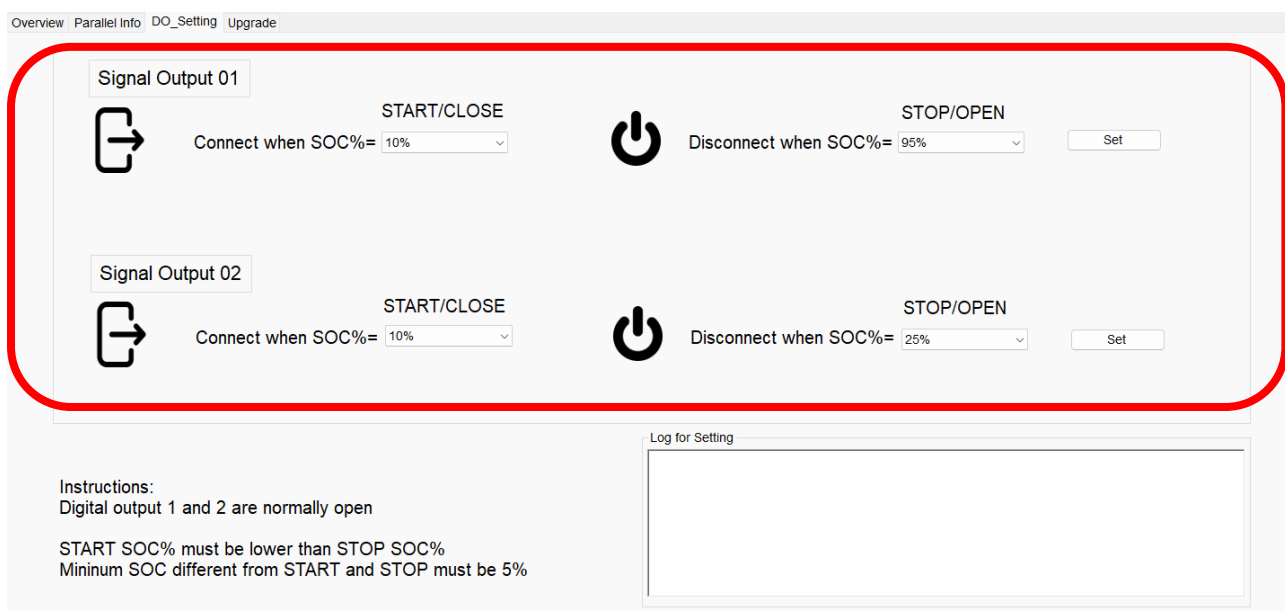

DO1 and 2 dry contacts (Digital Output 1 and 2) are two normally open contacts, which can be set to close within a user-defined range by setting the closing and opening threshold.

DO1 and 2 dry contacts are set in the same way. Below the examples refer to DO2, but the procedure and operation of DO1 are identical.

Set the % SoC below which the contact should close

Set the % SoC above which the contact should open

Signal Output 02

START/CLOSE

Connect when SOC%=

STOP/OPEN

Disconnect when SOC%=

Set

Press SET to enable the settings.

The thresholds can be set freely in the range between 0% and 100%, respecting the following rules:

1. The SoC percentage for closing the contact must be less than the SoC percentage for opening.
2. The difference between the SoC percentages of close and open cannot be less than 5%.

| DO technical data | |
|-------------------------------|---|
| | DO1 (DO1+, DO1-) not used; DO2 (DO2+, DO2-); |
| Type | Relay, dry contact |
| Voltage range | 5 to 30V DC or 5 to 250V AC |
| Rated current (max) | 2A |
| Lifetime mechanical (no load) | 20,000,000 open/close cycles |

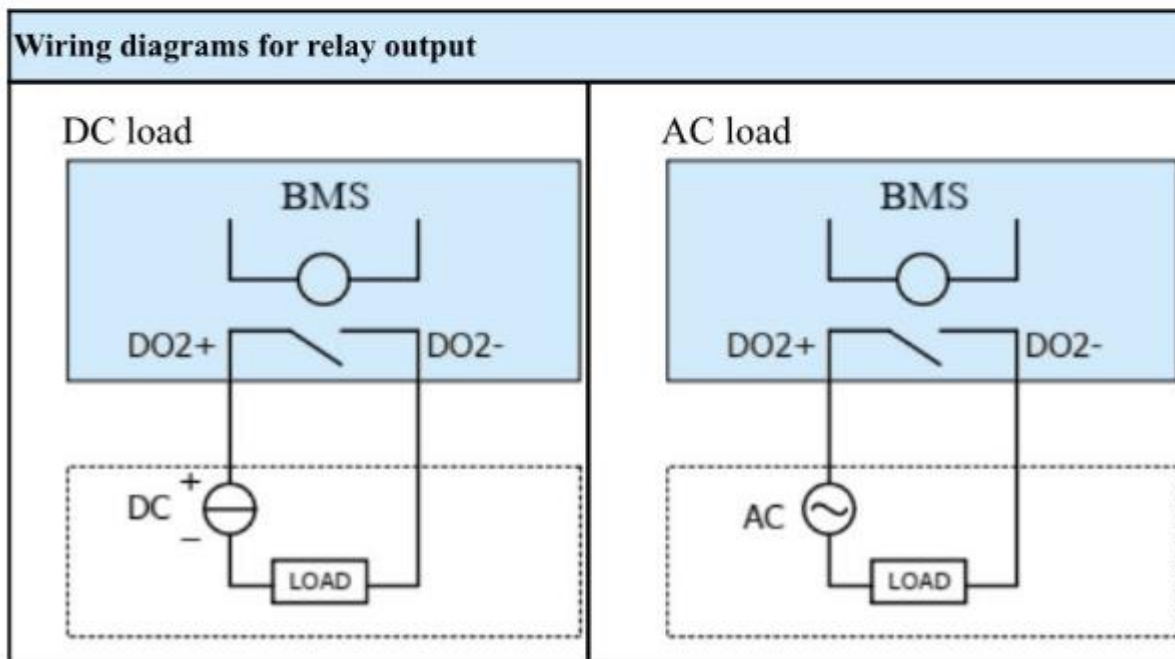

INVERTER TECHNICAL INFORMATION AND WORKING LOGIC

For use with WeCo batteries, any of the approved inverters must be used, which must operate within the parameters indicated below.

These parameters may be above or below the range provided in the performance warranty, so always refer to the WeCo limited warranty in order to set the inverter working parameters in accordance with the warranty, if the customer intends to comply with them to benefit from the performance guarantees.

A battery that operates outside the maximum (and minimum) values of current, voltage, temperature and any other parameters mentioned in the warranty, is no longer covered by the performance warranty.

| Description | Inverter: Low Voltage CUT OFF | Inverter: High Voltage CUT OFF | Standard charging current (*max 110A peak 30 sec) | Standard discharge current (*max 110A Peak 30sec) |
|------------------------|-------------------------------|--------------------------------|---|---|
| Single battery | 44.8 | 58,4 | 44A | 44A |
| Master + Slave1 | | | | |
| Master+SL1+SL2 | | | | |
| Master+SL1+SL2+SL3 | | | | |
| Master+SL1+SL2+SL3+SL4 | | | | |

| CHARGE | Temperature range * | C – rate* |
|--------|---------------------|-----------|
| | -2°C +5°C | 0,05C |
| | +6°C +9°C | 0,1C |
| | +10°C +14°C | 0,3C |
| | +15°C +45°C | 1C |
| | +46°C +50°C | 0,3 C |
| | +51°C +55°C | 0,1C |

| DISCHARGE | Temperature range * | C – rate* |
|-----------|---------------------|-----------|
| | -20°C -11°C | 0,1C |
| | -10°C -5°C | 0,2C |
| | -6°C 0°C | 0,3C |
| | +1°C +10°C | 0,5C |
| | +11°C +55°C | 1 C |
| | +56°C +65°C | 0,5C |

*Values are subjected to modifications and could be different from the above charts

| 4K4 LT | Low voltage |
|------------------------------------|--|
| Rated DC voltage at 25°C | 51.2Vdc |
| Useful Ah | 86Ah |
| Nominal capacity in kWh | 4.4 kWh |
| Total Battery capacity | 92Ah |
| Maximum charging current | 1C |
| Suggested charge/discharge current | 0.5C |
| DC voltage range (Mosfet Int.) | From 47.5 to 58.4 (Do not use as settings) |
| Maximum operational efficiency | 97% |
| Usage temperature (STC) | 25°C |
| Operating temperature of the BMS | -20° to 65°C (Temperature range not indicated in the warranty conditions are not covered by warranty) |
| BMS charging temperature | -10° to 55°C |
| Self-discharge rate (STC) | <1% loss per month |
| Dimensions | 490x580x155mm |
| Weight | 47Kg |



Caution:

WeCo 4K4LT has a special chemical composition lithium iron phosphate.

After the charging period, compared to the maximum voltage reached at 100% SoC, the total voltage can drop to about 53V: this is normal behavior.



Caution:

When the battery reaches the maximum voltage or cut-off threshold (SoC 100%) do not continue charging the battery.

In case of overvoltage of a single cell, the relay will open the circuit and the inverter will shut down if powered only by battery.

Check the correct setting of the inverter and check that the BMS battery information is readable by the inverter.

Failure to communicate between the inverter and the battery could cause serious damage to the battery.

4K4LT cannot be used in OPEN LOOP.

If the inverter is switched off, press the RUN button on the battery and turn off the battery as described in section 6.2.2 of this manual.

The BMS will perform a self-restart 4 times every 15 minutes for a 24-hour period and after the 24-hour period, the BMS will perform an auto-restart every 12 hours for a period of 4 days.



Information:

In case the current or voltage limit has been exceeded 4 times consecutively, the operator must wait 30 minutes before pressing the start button again.

⚠ Information:

A reduction in the charging current at the end of the charge and at the end of the discharge as well as a new setting of the voltage range is mandatory if the installation fails as described above.

Charging current step from 0% to 100%

Current steps may vary depending on the instantaneous condition of the battery.

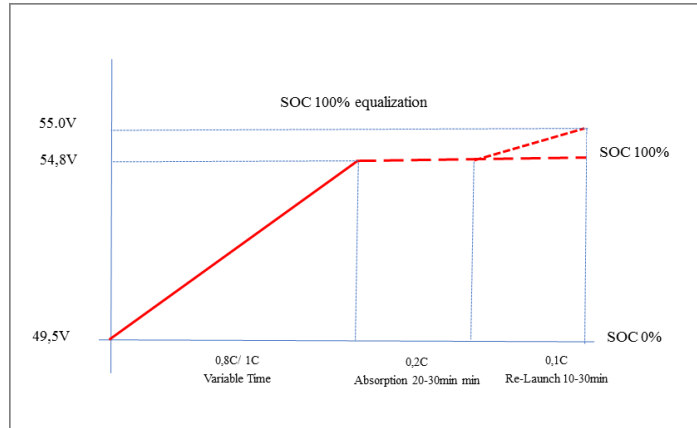

⚠ Caution:

The charging and discharging current of the inverter shall be limited according to the maximum current allowed by each battery cluster configuration.

The charging and discharging voltage range of the inverter shall be limited according to the maximum values of the module specified in this manual.

Open loop use and/or unapproved inverters void the warranty.

⚠ Caution:

DO NOT connect the 4K4 LT battery module to an inverter that does not have a BMS-CAN, the installation without BMS/CAN inverters is not allowed under any circumstances.

⚠ Caution:

USING THE BATTERY OUTSIDE THE WORKING RANGE DEFINED IN THIS MANUAL WILL DAMAGE THE BATTERY

USE OF THE BATTERY OUTSIDE THE STC I TEST CONDITIONS IN THE LIMITED WARRANTY WILL VOID THE WARRANTY.

⚠ Information:

This manual is subject to continuous implementation.

Before installing WeCo batteries, please contact our support team for the latest manual and any additional support.

Improving security is our priority. Any suggestions are welcome, and we thank you so far for your cooperation in improving the system.

WeCo Srl, Italy